

St/Doc

MINISTÈRE DE LA GUERRE

INSTRUCTION

SUR

**LES ARMES ET LES MUNITIONS
EN SERVICE**

APPROUVÉE LE 29 OCTOBRE 1905

PLANCHES



PARIS

IMPRIMERIE NATIONALE

1905

MINISTÈRE DE LA GUERRE

INSTRUCTION

SUR

LES ARMES ET LES MUNITIONS

EN SERVICE

INSTRUCTION

SUR

LES ARMES ET LES MUNITIONS

EN SERVICE

PLANCHES



PARIS

IMPRIMERIE NATIONALE

1905

MINISTÈRE DE LA GUERRE

INSTRUCTION

SUR

LES ARMES ET LES MUNITIONS
EN SERVICE

PLANCHES

APPROUVÉE LE 29 OCTOBRE 1905

PLANCHES



PARIS

IMPRIMERIE NATIONALE

1905

	Planches.
<i>Armes blanches.</i> — Sabres de cavalerie M ^{les} 1854 transformé et 1882.....	XVIII
————— Sabres de cavalerie M ^{le} 1896.....	XIX
————— Sabres de cavalerie M ^{les} 1822 et 1822 transformé; sabre d'adjudant M ^{le} 1845; sabre-baïonnette M ^{le} 1866.	XX
————— Épées de sous-officier et brigadier de gendarmerie, de sous-officier M ^{les} 1857, 1884 et 1887.....	XXI
<i>Lances</i> M ^{les} 1823 et 1890. <i>et 1913</i>	XXII
<i>Armes blanches.</i> — Sabres d'officier.....	XXIII
————— Épées d'officier.....	XXIV
<i>Cuirasses.</i> — Cuirasse de cuirassier M ^{le} 1855.....	XXV
<i>Accessoires.</i> — Nécessaire d'armes M ^{le} 1874; accessoires du revolver M ^{le} 1892.....	XXVI
————— Nécessaires de chambre M ^{les} 1895 et 1896; réparations des baguettes.....	XXVII
<i>Réparations des armes.</i> — Fusils, carabines et mousquetons....	XXVIII et XXIX
<i>Réparations des revolvers et des armes blanches</i>	XXX
<i>Caisse pour fusils</i> M ^{les} 1886 et 1886-M-93.....	XXXI
<i>Caisse transformée pour fusils</i> M ^{les} 1886 et 1886-M-93.....	XXXII
<i>Caisse pour carabines de cavalerie et de cuirassier</i> M ^{le} 1890.....	XXXIII
<i>Caisse transformée pour carabines de cavalerie et de cuirassier</i> M ^{le} 1890.....	XXXIV
<i>Caisse pour carabines de gendarmerie</i> M ^{le} 1890.....	XXXV
<i>Caisse transformée pour carabines de gendarmerie</i> M ^{le} 1890.....	XXXVI
<i>Caisse pour mousquetons d'artillerie</i> M ^{le} 1892.....	XXXVII
<i>Caisse transformée pour mousquetons d'artillerie</i> M ^{le} 1892.....	XXXVIII
<i>Caisse pour revolvers</i> M ^{les} 1873, 1874 et 1892.....	XXXIX
<i>Caisse n° 1 pour sabres de cavalerie</i>	XL
<i>Caisse n° 1 pour sabres de cavalerie</i> M ^{le} 1896 (1 ^{re} taille).....	XLI
<i>Caisse n° 2 pour sabres de cavalerie</i>	XLII
<i>Caisse n° 2 pour sabres de cavalerie</i> M ^{le} 1896 (2 ^e taille).....	XLIII
<i>Caisse n° 3 pour sabres de cavalerie</i>	XLIV
<i>Caisse pour lances</i> M ^{le} 1823.....	XLV
<i>Caisse pour lances</i> M ^{le} 1890.....	XLVI
<i>Caisse pour lances</i> M ^{le} 1913.....	XLVI bis
<i>Caisse pour cuirasses</i> M ^{le} 1855.....	XLVII

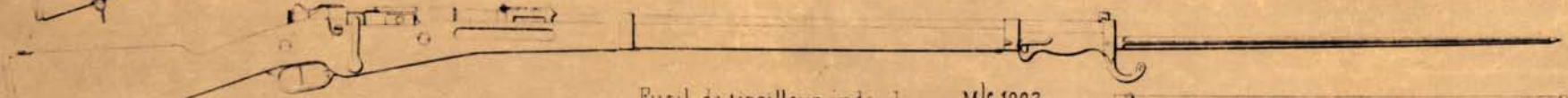
	Planches.
<i>Cartouches.</i> — Cartouches pour fusils, carabines et mousqueton.....	XLVIII
————— Cartouches pour revolvers M ^{les} 1873, 1874 et 1892.....	XLIX
<i>Caisse blanches à munitions.</i> — N° 3-M ^{le} 1877, n° 4, n° 5 de montagne, pour cartouches sans balle.....	L
————— M ^{les} T, C-1, C-1 bis, C-2 et C-2 bis...	LI
<i>Coffres à munitions.</i> — Coffre M ^{le} 1858 non allongé; coffre M ^{le} 1858 allongé.	LII
<i>Coffres à munitions et caisse à munitions de montagne.</i> — Coffres à munitions de voiture de compagnie M ^{le} 1891 et de caisson léger à munitions d'in- fanterie; caisse à munitions de montagne M ^{le} 1862.....	LIII

Vue d'ensemble des armes. (1/3).

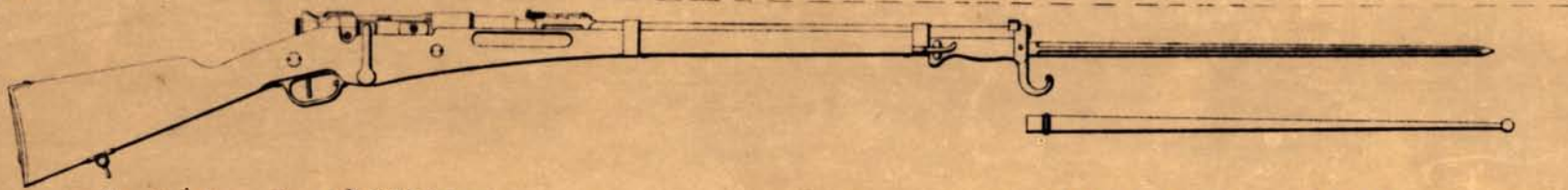
Fusil M^{le} 1886 M 93



Fusil Colonial M^{le} 1907.



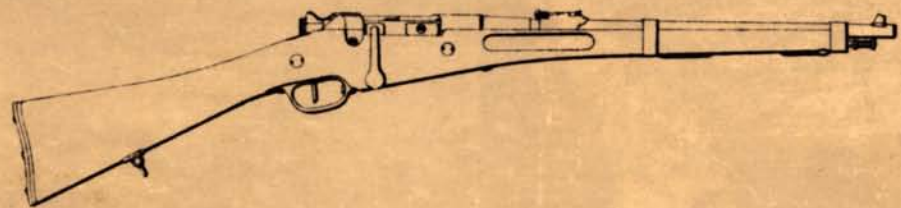
Fusil de tirailleur indo-chinois M^{le} 1907.



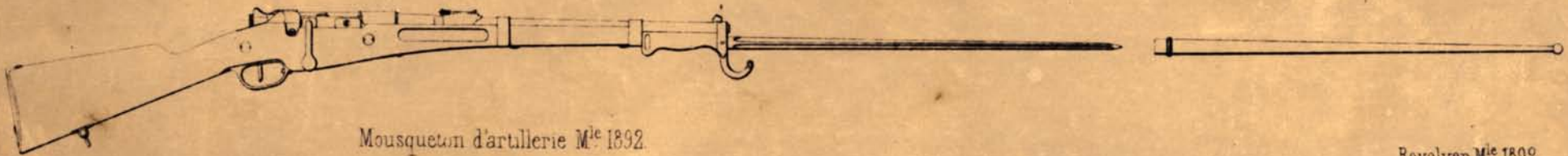
Carabine de cavalerie M^{le} 1890 (2^e type).



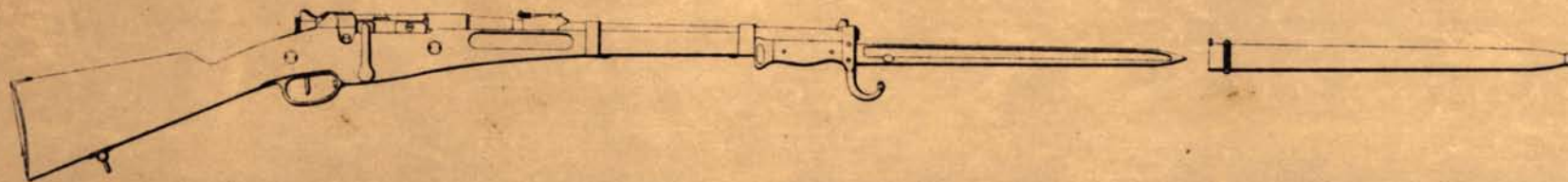
Carabine de cuirassier M^{le} 1890.



Carabine de gendarmerie M^{le} 1890.



Mousqueton d'artillerie M^{le} 1892.



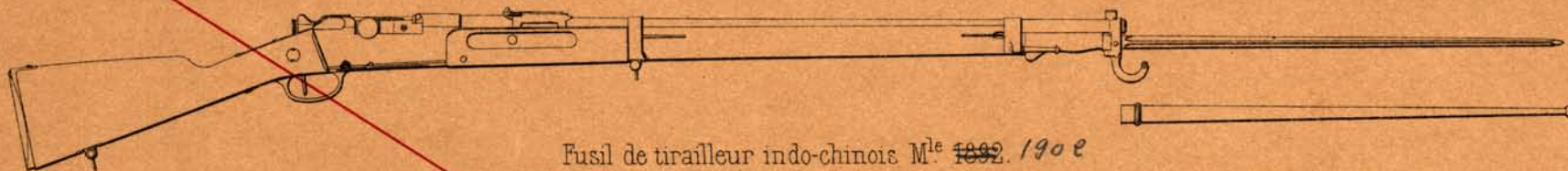
Revolver M^{le} 1892



PL. I

Vue d'ensemble des armes. ($\frac{1}{8}$).

Fusil M^{le} 1886 M 93.



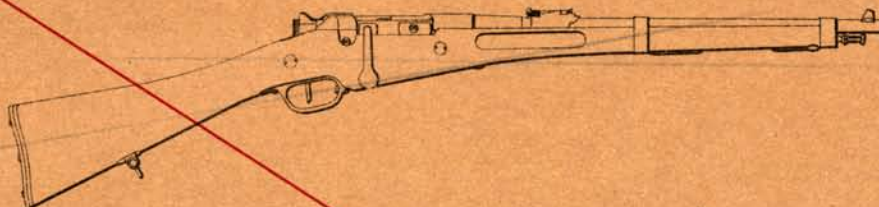
Fusil de tirailleur indo-chinois M^{le} 1892. 1900



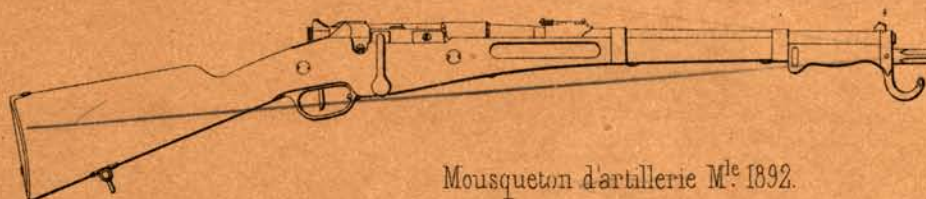
Carabine de cavalerie M^{le} 1890 (2^e type).



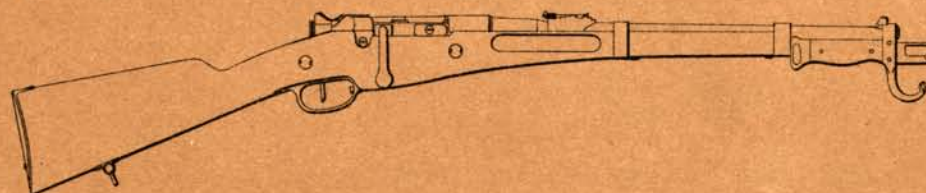
Carabine de cuirassier M^{le} 1890.



Carabine de gendarmerie M^{le} 1890.



Mousqueton d'artillerie M^{le} 1892.



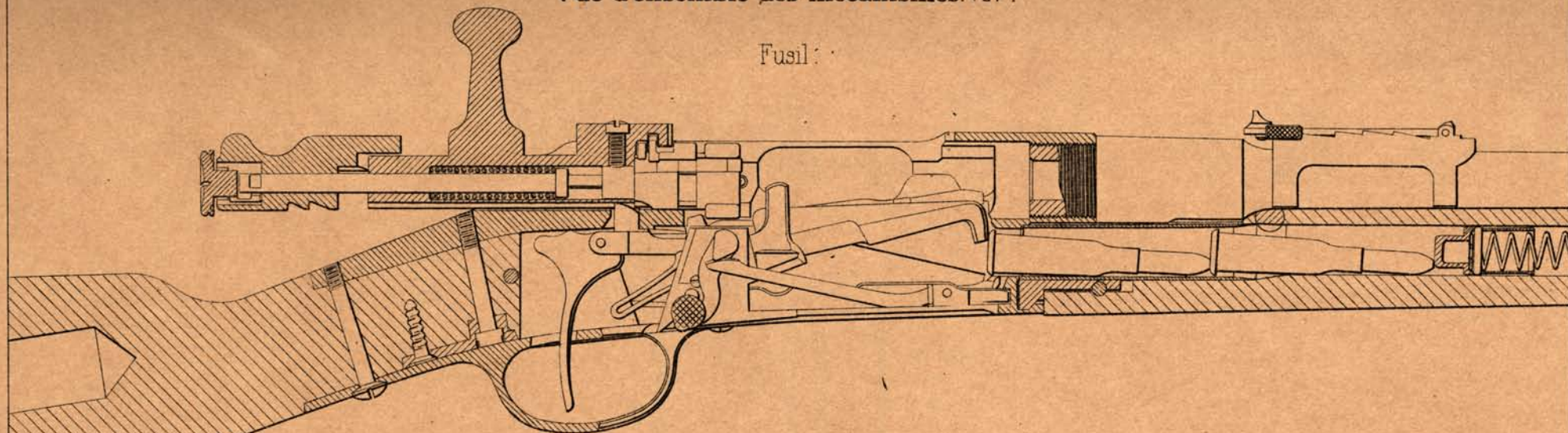
Revolver M^{le} 1892.



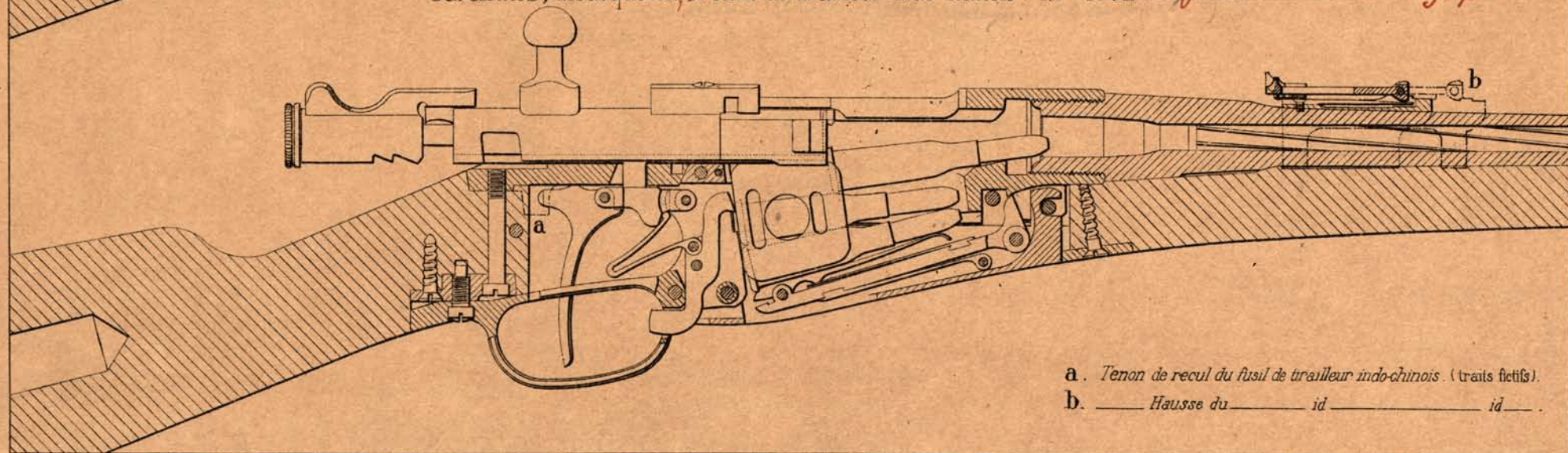
PL. I.

Vue d'ensemble des mécanismes. ($\frac{1}{2}$).

Fusil :



Carabines, Mousqueton, et fusil de traillleur indo-chinois. M^{le} 1902 et *fusil colonial M^{le} 1907*



- a. Tenon de recul du fusil de traillleur indo-chinois. (traits fictifs).
- b. _____ Hausse du _____ id _____ id _____

Canon. — Hausse. — Boîte de culasse. ($\frac{1}{2}$).

Canon

Fig 1 Vue du côté gauche

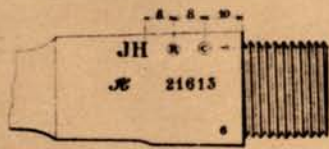


Fig 2 Vue du côté droit

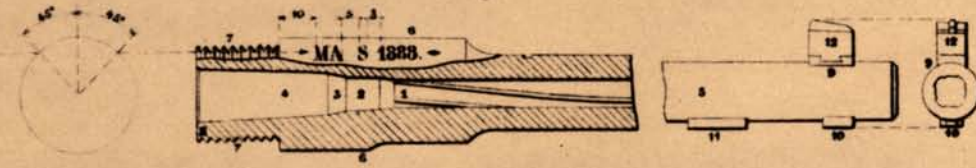
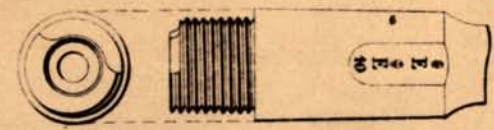


Fig 3 Vue du dessous



Hausse montée

Fig 4

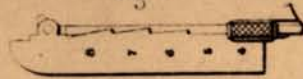


Fig 5



Fig 6 Pied du type primitif à oreilles renforcées

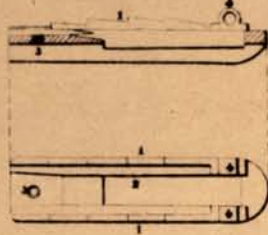


Fig 7 Pied à griffes

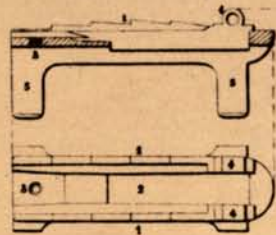


Fig 8 Blanchettes de hausse et curseurs
Cartouche M^{le} 1886 M. Cartouche M^{le} 1886 D.

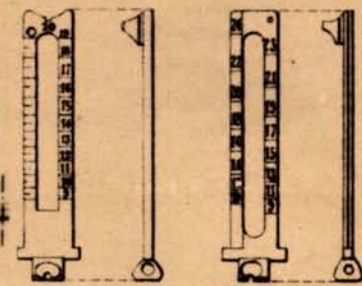


Fig 13 Ressort de curseur



Vis de ressort de hausse

Fig 10 pour pied à griffes



Fig 11 pour pied ordinaire



Fig 12 Ressort de hausse

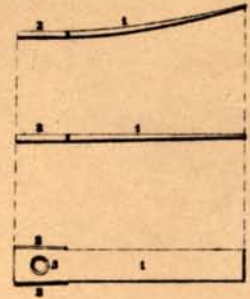


Fig 14 Goupille



Fig 15 Vis arrêt de curseur



Boîte de culasse.

Fig 16 Coupe de la queue de culasse M^{le} 1886.



Fig 19 Coupe de la queue de culasse M^{le} 1886-93

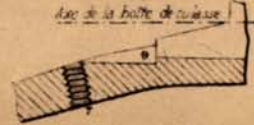


Fig 20 Vis éjecteur

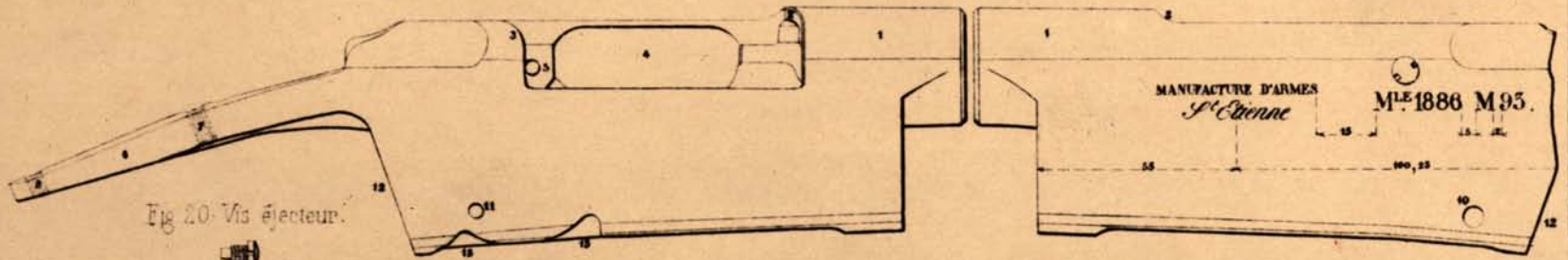


Fig 17 Joue gauche

Canon. — Hausse. — Boîte de culasse. (1/2).

Canon.

Fig. 1. Vue du côté gauche.



Fig. 2. Vue du côté droit.

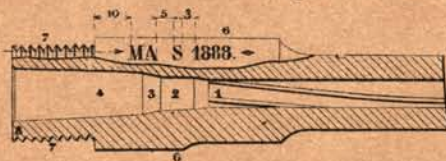
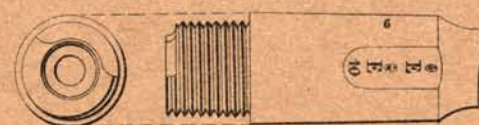


Fig. 3. Vue du dessous.



Hausse montée.



Fig. 6. Pied du type primitif à oreilles renforcées.

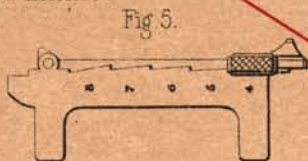
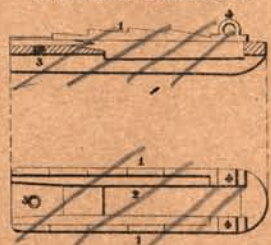


Fig. 7. Pied à griffes.

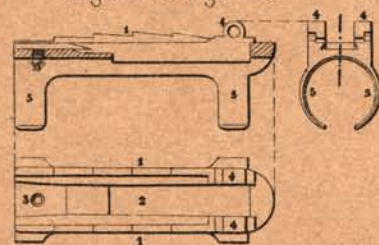


Fig. 8. Planche de hausse.



Fig. 9. Curseur.

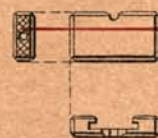


Fig. 13. Ressort de curseur.



Vis de ressort de hausse.

Fig. 10. pour pied à griffes.



Fig. 11. pour pied ordinaire.



Fig. 12. Ressort de hausse.



Fig. 14. Goupille.



Fig. 15. Vis arrêteur de curseur.



Boîte de culasse.

Fig. 16. Vue du côté droit.

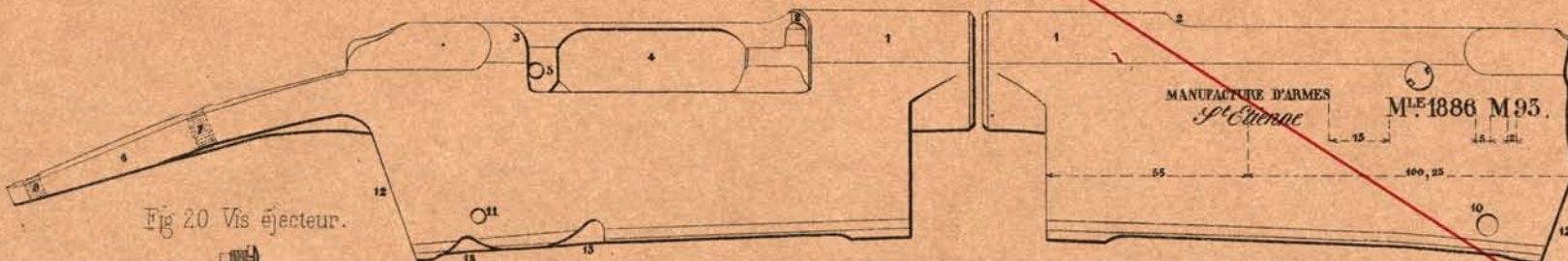


Fig. 17. Joue gauche.

Fig. 18. Coupe de la queue de culasse M^e 1886.

Axe de la boîte de culasse



Fig. 19. Coupe de la queue de culasse M^e 1886-93.

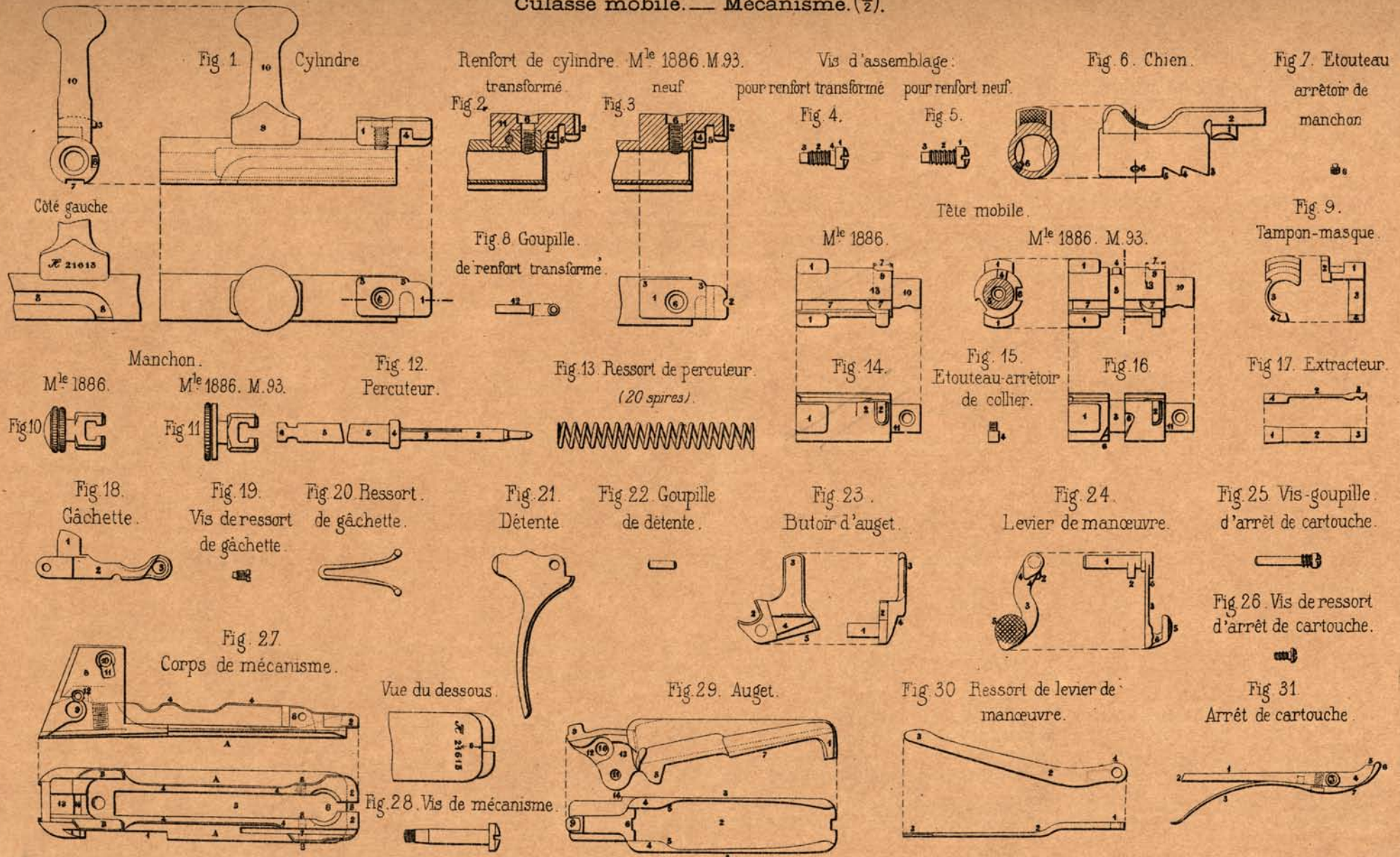
Axe de la boîte de culasse



Fig. 20. Vis éjecteur.



Culasse mobile. — Mécanisme. (1/2).



PL. IV.

Monture et garnitures. — Baguette. ($\frac{1}{2}$).

Fig. 1.
Crosse. ($\frac{1}{4}$)

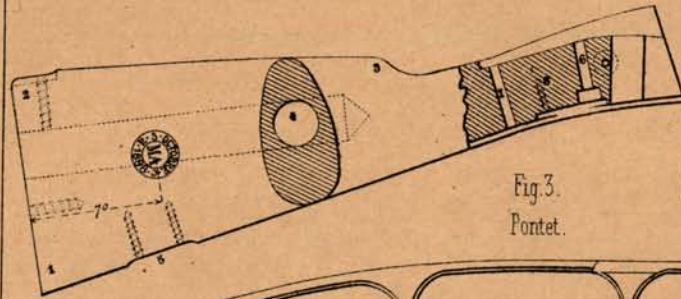


Fig. 2. Fût. ($\frac{1}{4}$)



Vue du dessous.



Fig. 3.
Pontet.

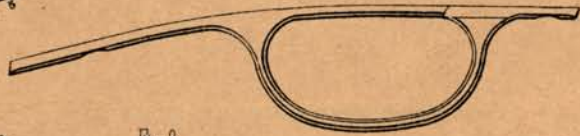


Fig. 4.
Support d'oreille.

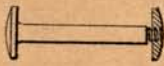


Fig. 5.
Cheville de bouchon.



Fig. 6.
Cheville de fût.

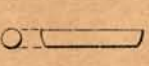


Fig. 7.
Bouchon de magasin.



Joue gauche.

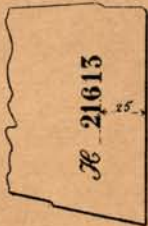


Fig. 8.
Embase de battant.

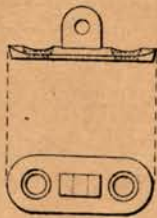


Fig. 9. Vis postérieure de pontet.



Fig. 10.
Vis antérieure de pontet.



Fig. 11.
Support de vis de culasse.

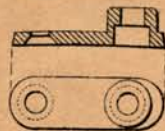


Fig. 12.
Ressort d'embouchoir.



Fig. 13.
Grenadière.

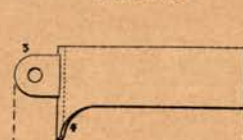


Fig. 14.
Embouchoir.

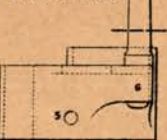


Fig. 15.
Anneau de battant.

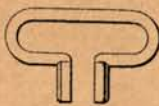


Fig. 16. Vis de culasse.



Fig. 17.
Ressort de grenadière.

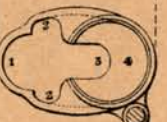
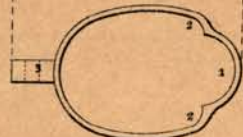


Fig. 18. Plaque de couche.

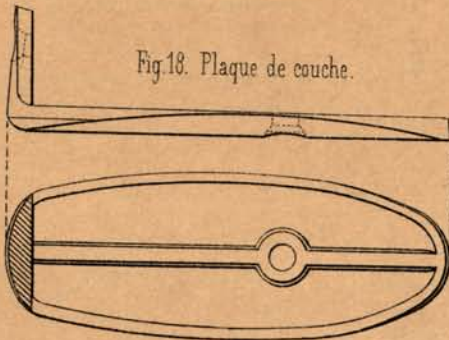


Fig. 19. Tube-arrêt de piston.

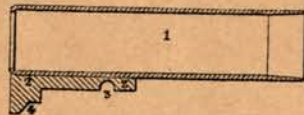


Fig. 20.
Goupille de piston.



Fig. 21. M^{le} 1886.



Fig. 21^{bis}. M^{le} 1898.



Fig. 22. Ressort de magasin.
(75 à 80 spires).



Fig. 23. Goupille de tube-arrêt.

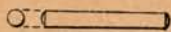
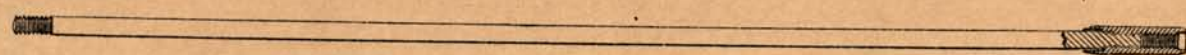
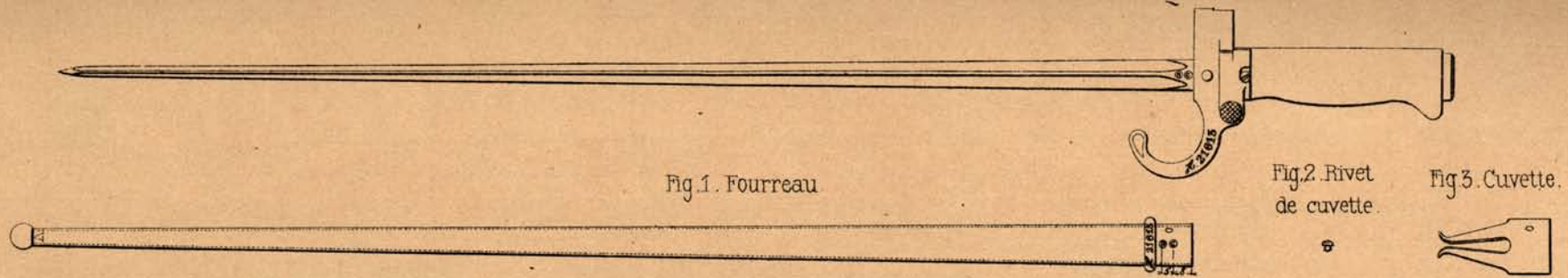


Fig. 24. Baguette



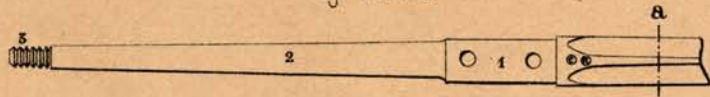
PL. V.

Épée - baïonnette



Lame à soie allongée. ($\frac{1}{2}$).

Fig. 4. Soie.



Section a.



Lame à soie courte. ($\frac{1}{2}$).

Fig. 5. Soie.

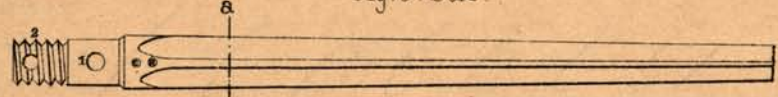


Fig. 6. Poignée.

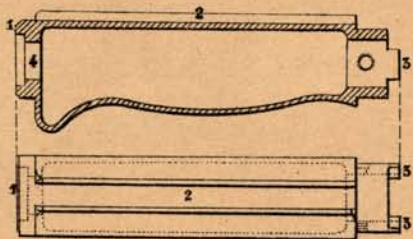


Fig. 7. Croisière.

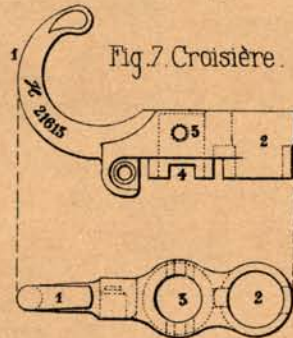


Fig. 10. Rivet de croisière.



Fig. 14. Vis de poignée.



Fig. 8. Poignée.

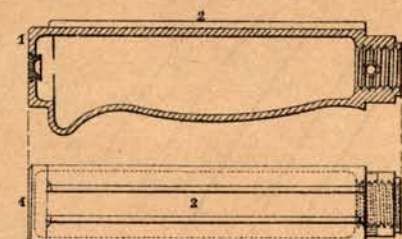


Fig. 9. Croisière.

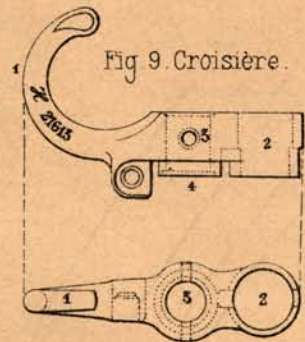


Fig. 11. Virole.

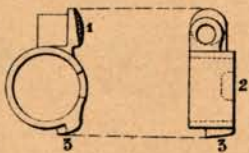


Fig. 12. Ressort de poussoir. (7. Spires).



Fig. 13. Ecou de poignée.



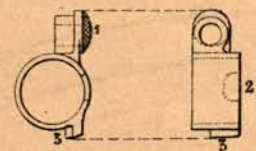
Fig. 15. Bouchon de poignée.



Fig. 16. Ressort de poussoir. (6. Spires).



Fig. 17. Virole.



Canon. — Hausse. — Boîte de culasse. ($\frac{1}{2}$).

Fig. 1. Canon.

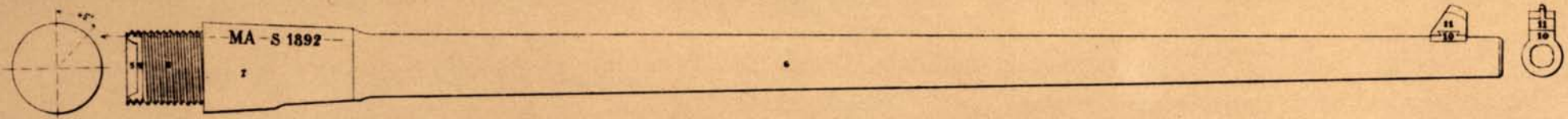


Fig 2. Vue du côté gauche.

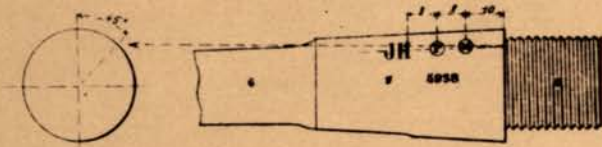


Fig 3. Coupe longitudinale

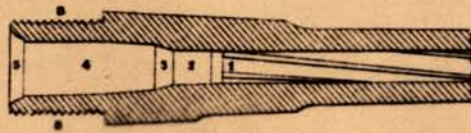
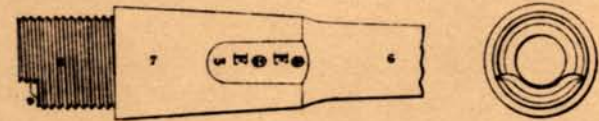


Fig. 4. Vue du dessous.



Hausses.

Planches de hausse et curseurs.

Fig 5. Pied de hausse.

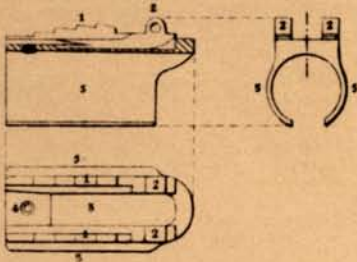
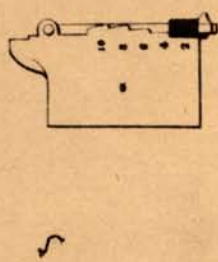


Fig 6. Hausse montée.



Cartouche M^{le} 1886 M. Cartouche M^{le} 1886 D.

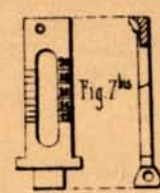
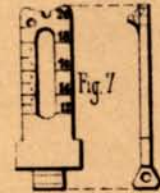


Fig 9. Vis arrêtoir de curseur.



Fig 10. Vis de ressort de hausse.



Fig 11.

Ressort de hausse:

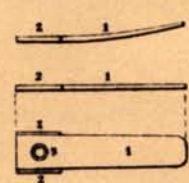


Fig 12. Ressort de curseur.

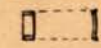
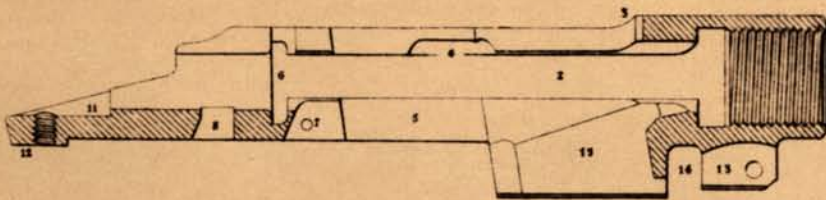


Fig 13. Goupille.



Fig 14. Coupe longitudinale.

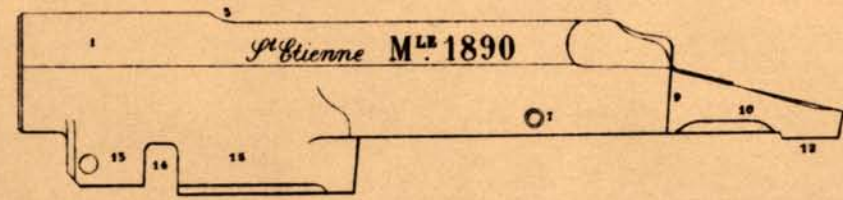


Boîte de culasse.

Fig 16. Goupille de chape d'assemblage.



Fig 15. Vue du côté gauche.



Canon. — Hausse. — Boîte de culasse. ($\frac{1}{2}$).

Fig.1. Canon.



Fig.2. Vue du côté gauche.

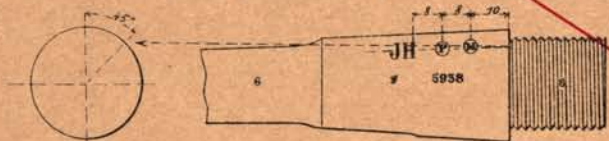


Fig.3. Coupe longitudinale.

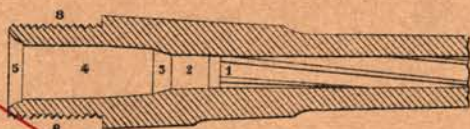
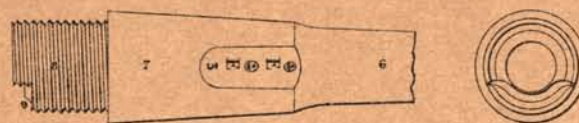


Fig.4. Vue du dessous.



Hausse.

Fig.5. Pied de hausse.

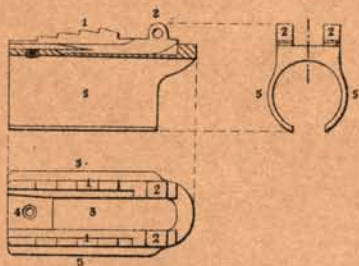


Fig.6. Hausse montée.

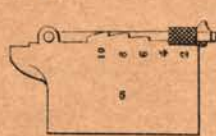


Fig.7. Plaque de hausse.

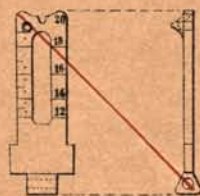


Fig.8. Curseur.

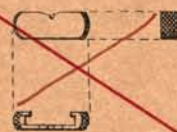


Fig.9. Vis-arrêt de curseur.



Fig.10. Vis de ressort de hausse.



Fig.11.

Ressort de hausse.

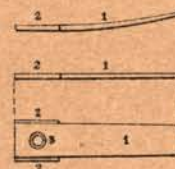


Fig.12. Ressort de curseur.



Fig.13. Goupille.



Boîte de culasse.

Fig.14. Coupe longitudinale.

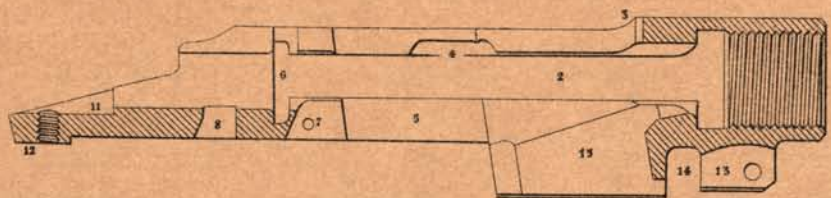


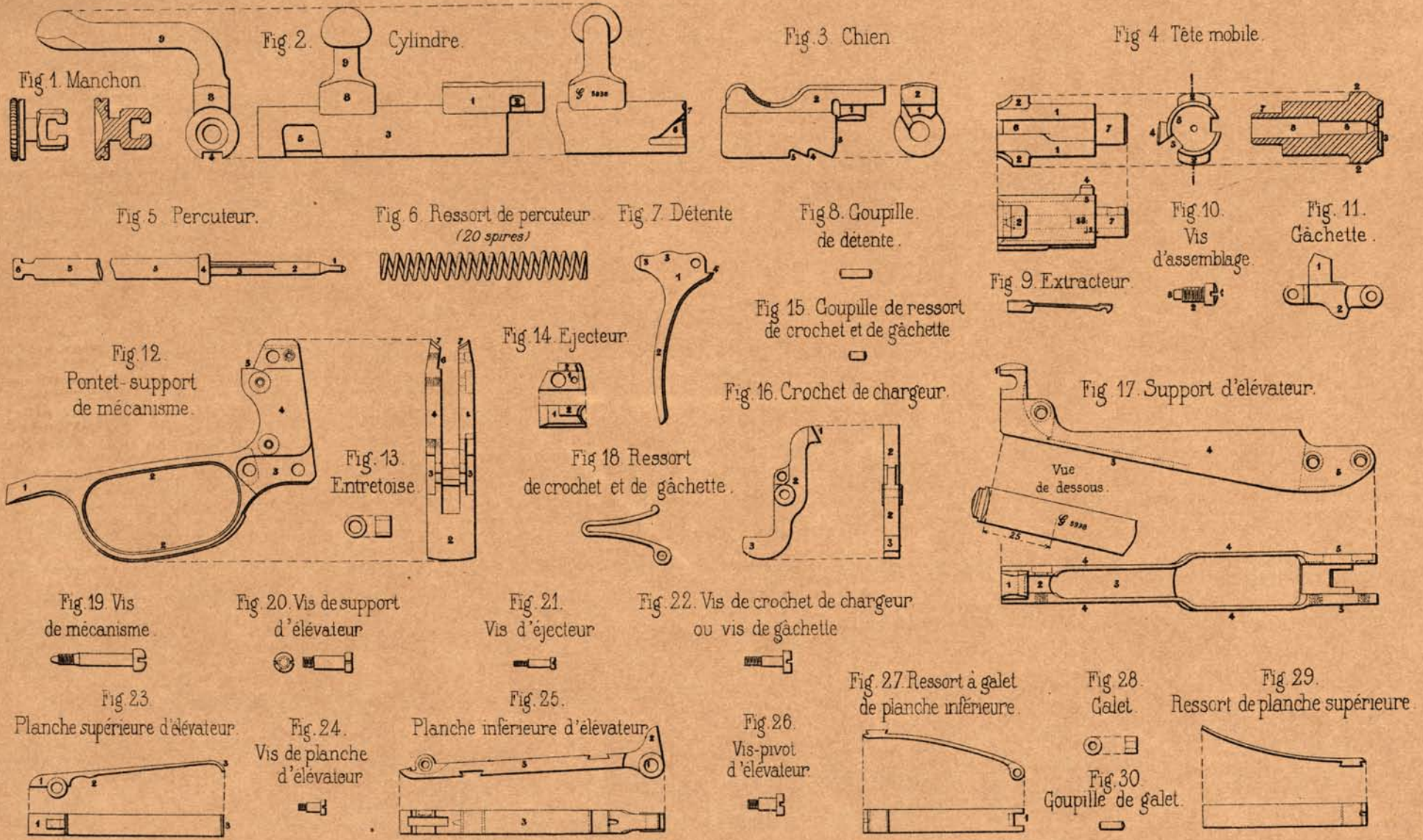
Fig.16. Goupille de chape d'assemblage.



Fig.15. Vue du côté gauche.



Culasse mobile. — Mécanisme. ($\frac{1}{2}$).



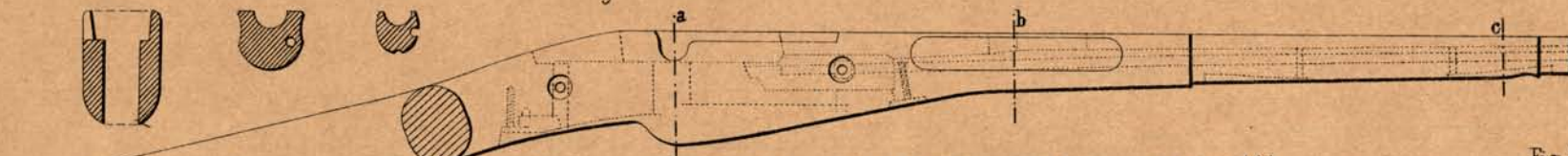
PL. VIII.

Montures et garnitures. ($\frac{1}{2}$).

Section a. Section b. Section c.



Fig. 1. Monture de carabine de cuirassier. ($\frac{1}{4}$).



Monture de carabine de cavalerie. ($\frac{1}{4}$).

Fig. 2. Crosse. (1^{er} type)

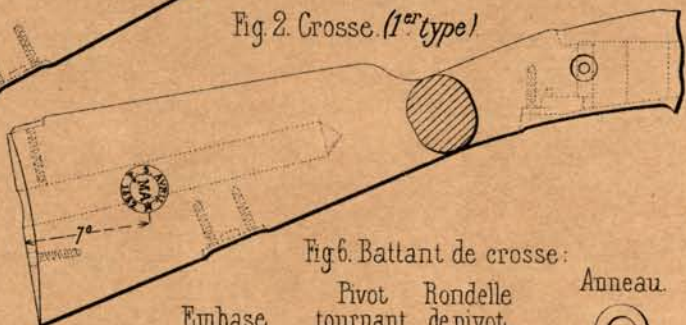


Fig. 3. Crosse. (2^e type).

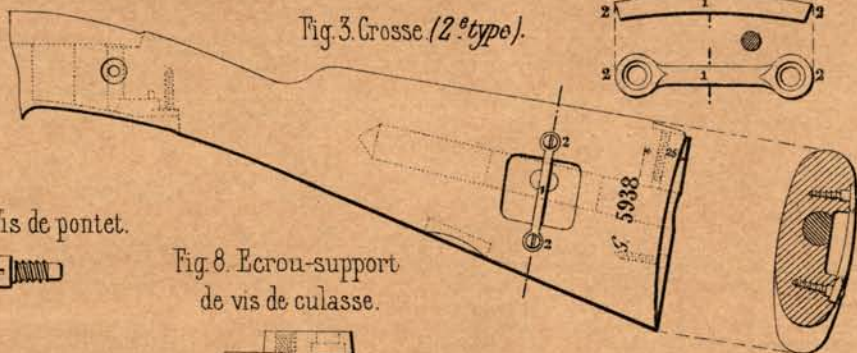


Fig. 24. Barrette.

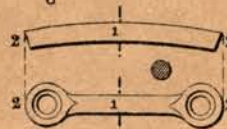


Fig. 4. Taquet de support d'élevateur.



Fig. 5. Vis à bois de taquet.

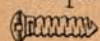


Fig. 6. Battant de crosse:

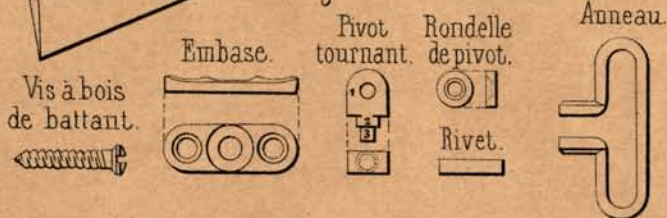


Fig. 7. Vis de pontet.



Fig. 8. Ecrou-support de vis de culasse.

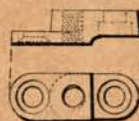


Fig. 9. Vis de culasse.

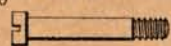
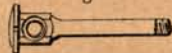


Fig. 10. Vis à bois d'écrou-support.



Fig. 11. Support d'oreilles-écrou de baguette.



Carabine de cavalerie.

Fig. 13. Plaque de couche.

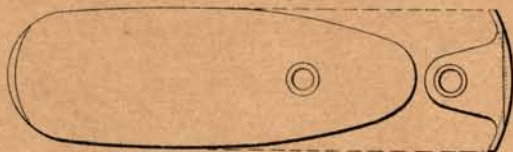


Fig. 14. Grenadière. (à anneau).

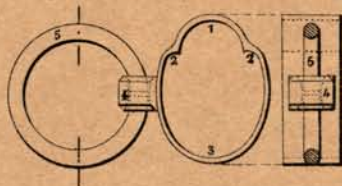
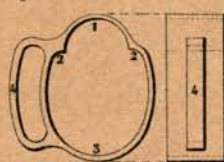


Fig. 15. Grenadière. (à pontet).



Ressorts:

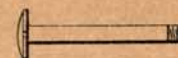
Fig. 16. de grenadière.



Fig. 17. d'embouchoir.



Fig. 18. Support d'oreilles.



Carabine de cuirassier.

Fig. 20. Plaque de couche en cuir.



Fig. 21. Baguette.



Fig. 22. Embouchoir.

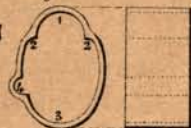


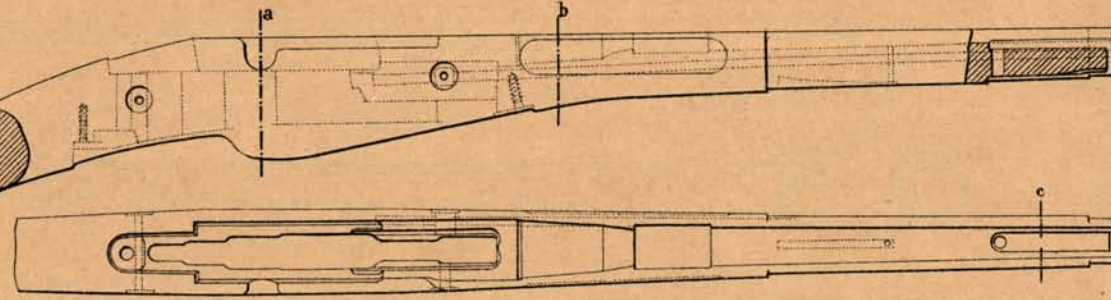
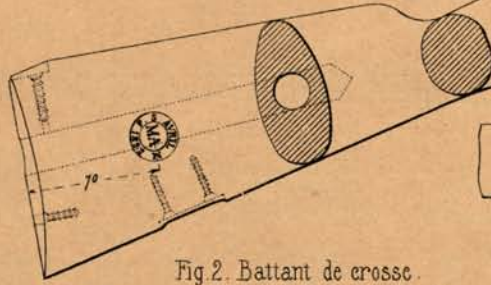
Fig. 23. Ecrou commun aux 2 supports.



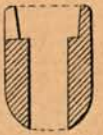
Monture et garnitures. ($\frac{1}{2}$).

Fig 1 Monture. (+)

Vue de la joue gauche.



Section a



Section b.

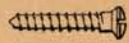


Section c.

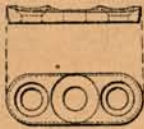


Fig 2. Battant de crosse.

Vis à bois de battant.



Embase.



Pivot tournant.



Rondelle de pivot.



Rivet.



Anneau.

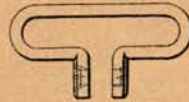


Fig 3. Ecrrou-support de vis de culasse.

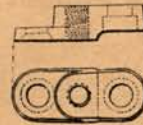


Fig 4.

Vis à bois d'écrrou-support.



Fig 5. Taquet de support d'élevateur.

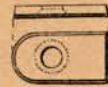


Fig 6. Vis à bois de taquet.

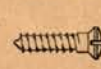


Fig 7. Support d'oreilles.



Fig 8. Plaque de couche.

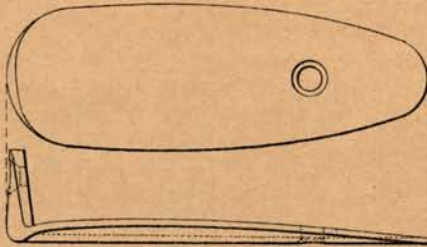


Fig 9. Tube d'appui.



Fig 10. Tenon à fourche.

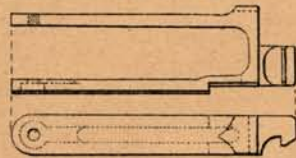


Fig 11. Anneau de grenadière.

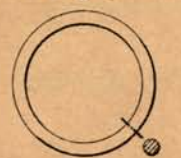


Fig 12. Grenadière.

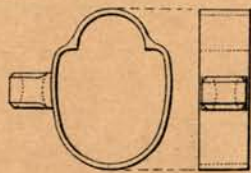


Fig 13. Embouchoir.

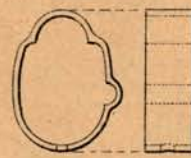


Fig 13^{bis}. Embouchoir à quillon pour mousqueton M^{le} 1902.

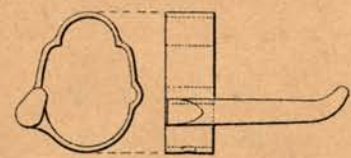


Fig 15. Vis de ressort d'embouchoir.



Fig 16. Écrrou commun aux 2 supports.



Fig 19. Ressort de grenadière.

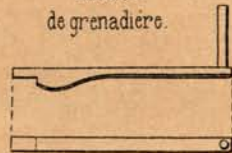


Fig 20. Ressort d'embouchoir.

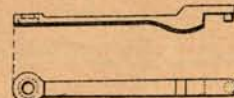


Fig 21. Vis de pontet.



Fig 17. Vis à bois de plaque de couche.

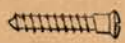


Fig 14. Support d'oreilles-écrrou de baguette.

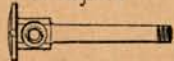


Fig 18. Baguette.

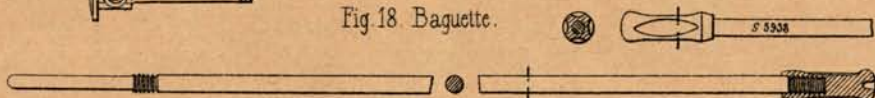
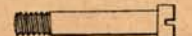
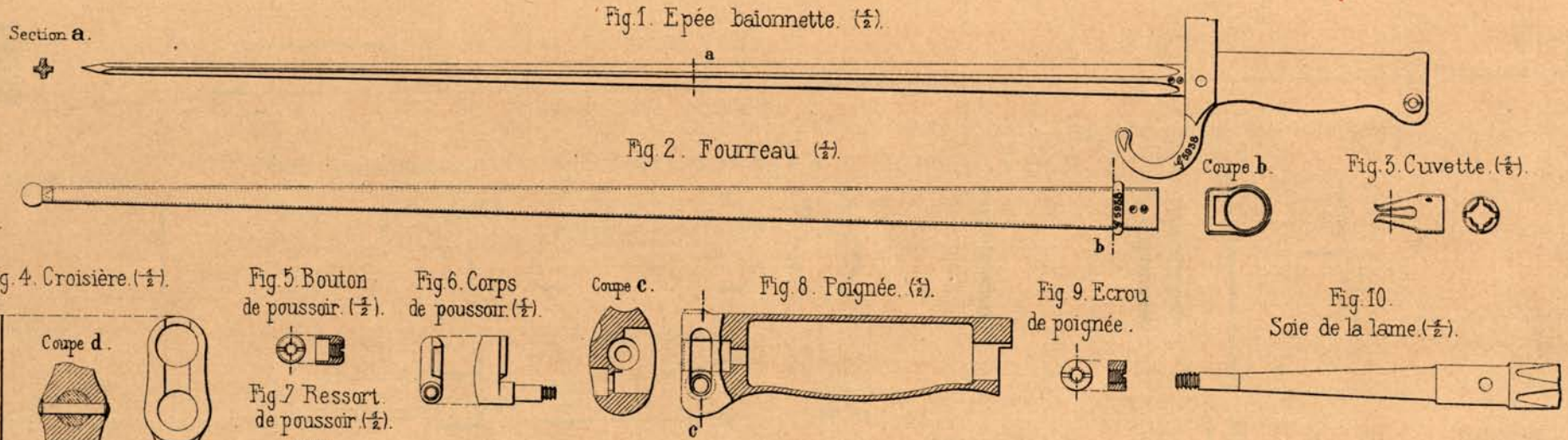


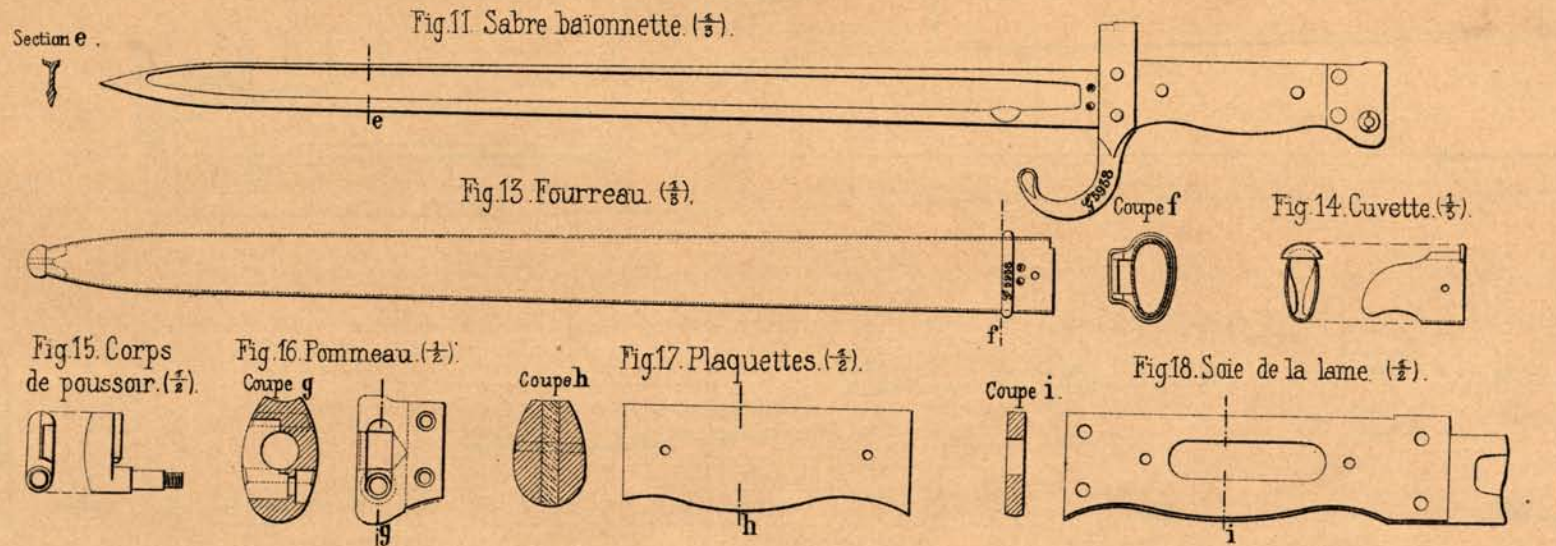
Fig 22. Vis de culasse.



Epée-baïonnette de carabine de gendarmerie, ~~et~~ de fusil de tirailleur indo-chinois *et fusil colonial*.



Sabre-baïonnette d'artillerie.



Canon — Hausse. — Monture. — Garniture (1/2).

Porte-chiffons.

Canon



Fig 11 Tenon de recul de la boîte de culasse.

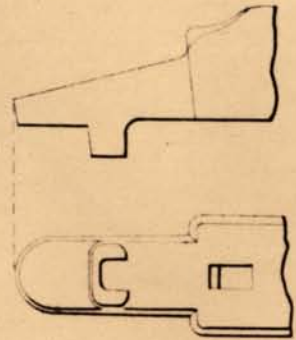


Fig 2 Hausse montée.

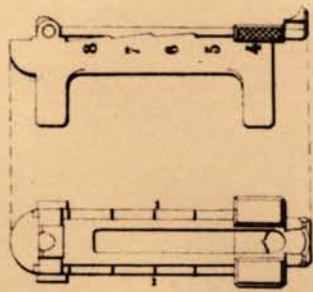


Fig 3 Pied de hausse à griffes.

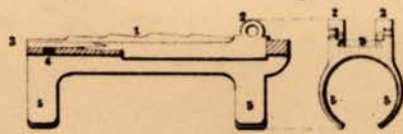


Fig 4 Ressort de hausse.



Fig 5 Vis de ressort de hausse



Fig 6. Planches de hausse et curseurs. Cartouche M^{re} 1886 M. Cartouche M^{re} 1886 D

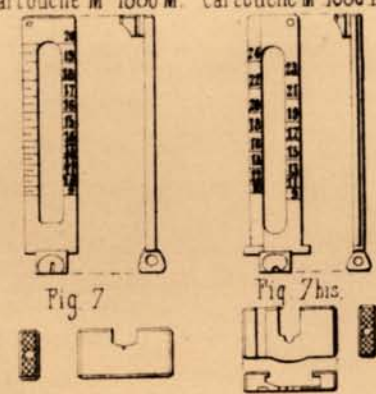


Fig 1 Guidon (1/4)

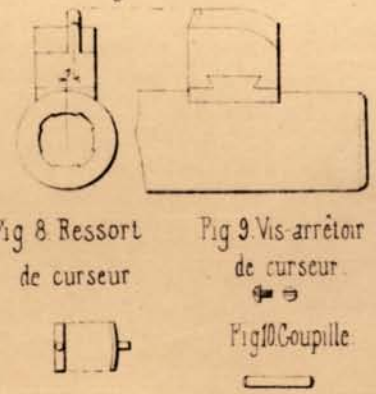


Fig 8. Ressort de curseur

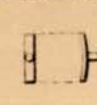


Fig 9. Vis-arrêt de curseur

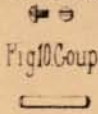
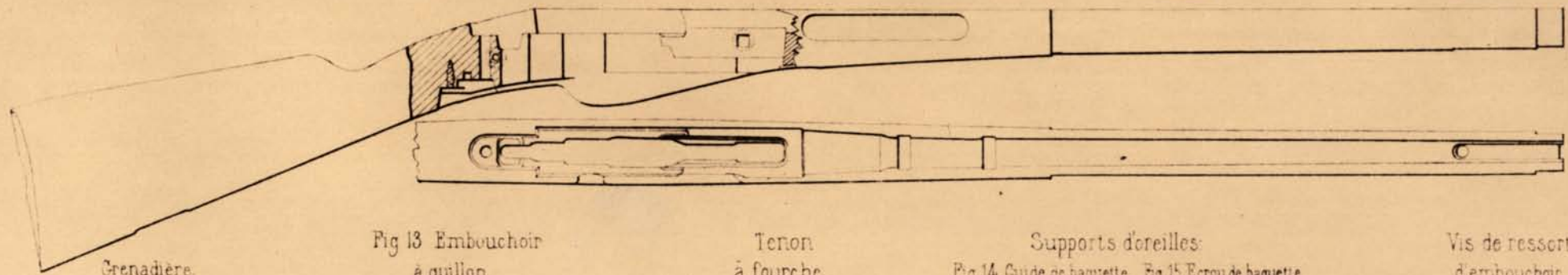


Fig 10. Coupille



Fig 12. Monture. (1/4)



Grenadière.

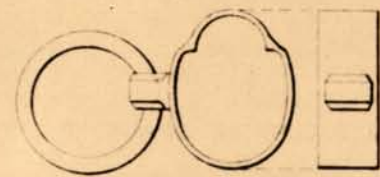
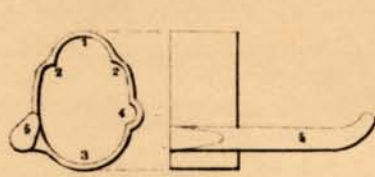
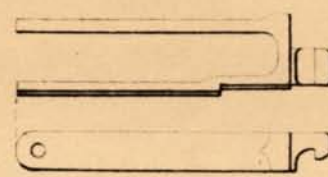


Fig 13 Embouchoir à quillon

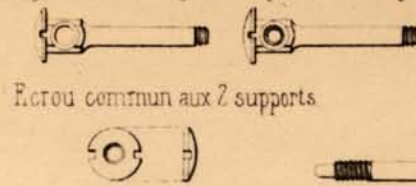


Tenon à fourche

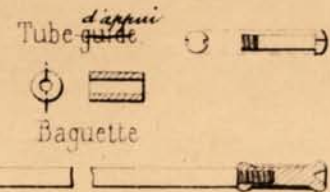


Supports d'oreilles:

Fig 14. Guide de baguette. Fig 15. Ecrou de baguette.



Vis de ressort d'embouchoir



Tube guide
Baguette

Ecrou commun aux 2 supports



Canon — Hausse — Monture — Garniture. ($\frac{1}{2}$).

Canon.



Fig 11 Tenon de recul de la boîte de culasse.

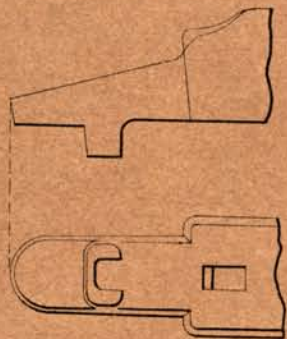


Fig 2 Hausse montée.

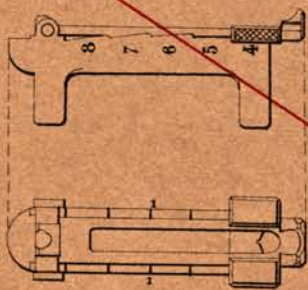


Fig 3 Pied de hausse à griffes.

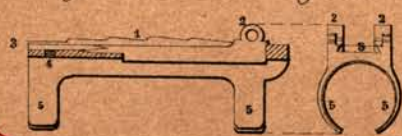


Fig 6 Planche de hausse.



Fig 8 Ressort de curseur.



Fig 1 Guidon ($\frac{1}{4}$).

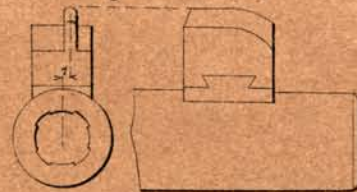


Fig 4 Ressort de hausse.



Fig 5. Vis de ressort de hausse.



Fig 7 Curseur.



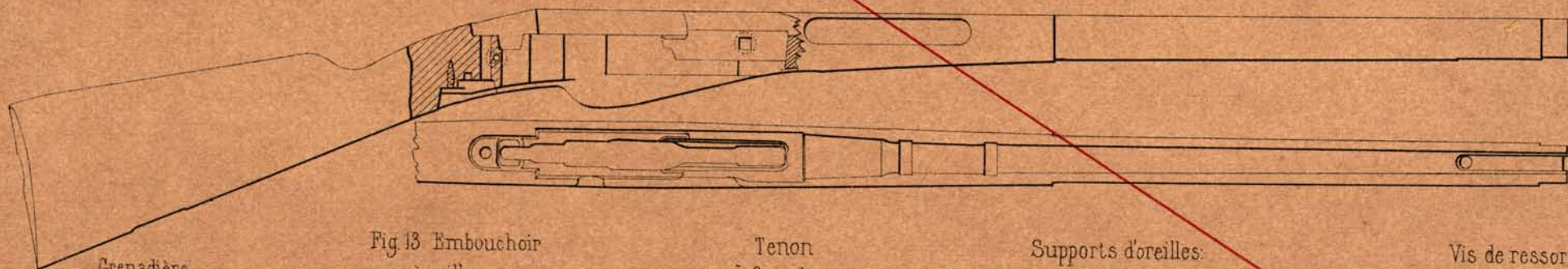
Fig 9. Vis-arêteoir de curseur.



Fig 10. Goupille.



Fig 12 Monture. ($\frac{1}{4}$).



Grenadière.

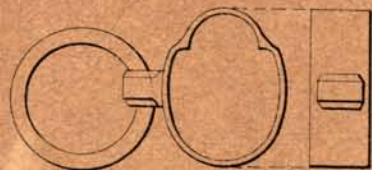
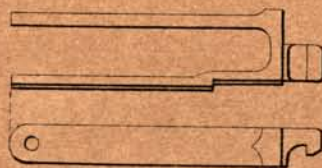


Fig 13 Embouchoir à quillon.

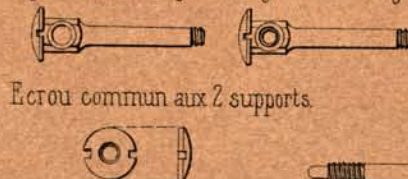


Tenon à fourche.



Supports d'oreilles.

Fig 14. Guide de baguette. Fig 15. Ecrrou de baguette.



Ecrrou commun aux 2 supports.



Vis de ressort d'embouchoir.



Tube guide.
d'appui
Baguette.



Canon. — Hausses. — Monture. — Garnitures. ($\frac{1}{2}$).

Canon

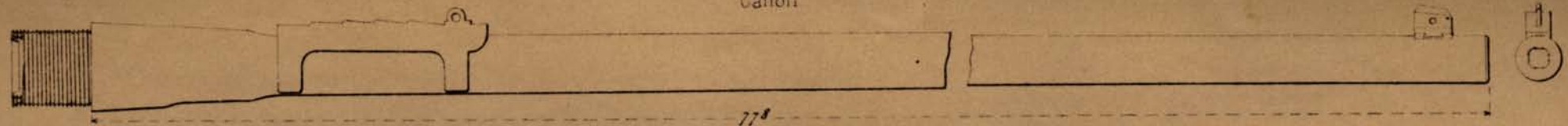


Fig. 1. Gandon

Fig. 6. Planches de hausse et curseurs.
Cartouche M^{le} 1886 M. Cartouche M^{le} 1886 D

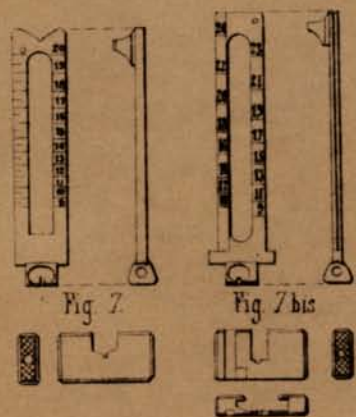


Fig. 2. Hausse montée.

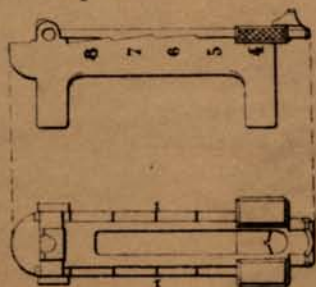


Fig. 3. Pied de hausse à griffes.

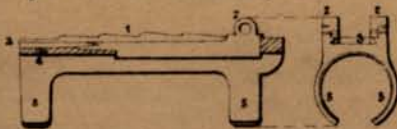


Fig. 4. Ressort de hausse.



Fig. 5. Vis de ressort de hausse.

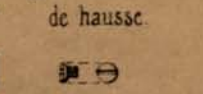


Fig. 11. Tenon de recul de la boîte de cuisse.

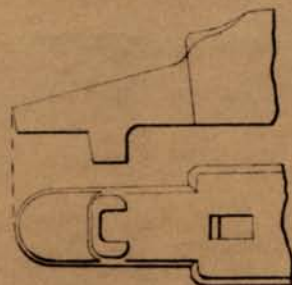


Fig. 16. Plaque de couche.

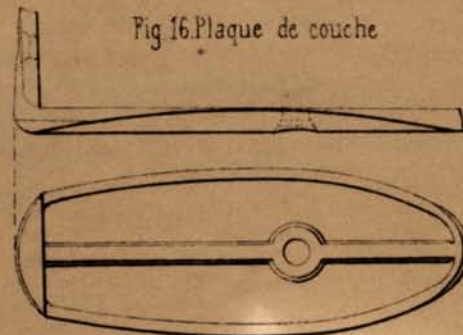


Fig. 10. Coupille.



Fig. 12. Monture. ($\frac{1}{4}$)

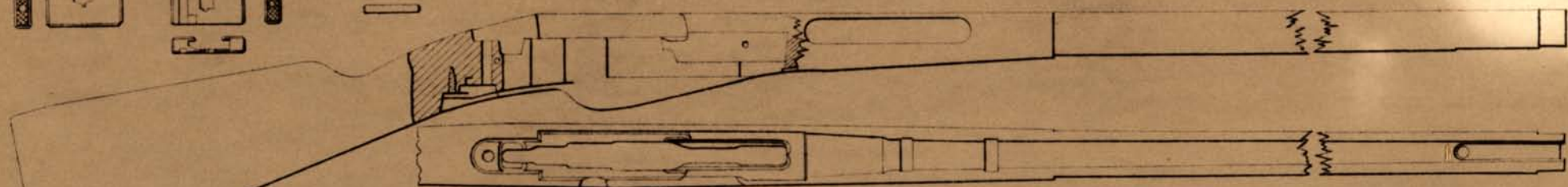


Fig. 13. Embouchoir à quillon

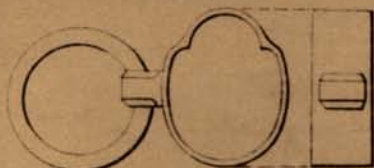


Fig. 8. Ressort de curseur.



Fig. 9. Vis-arrêtoir de curseur



Vis de ressort d'embouchoir

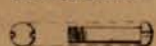


Fig. 14. Support d'oreille.



Tube d'appui.

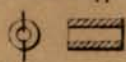
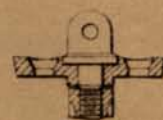
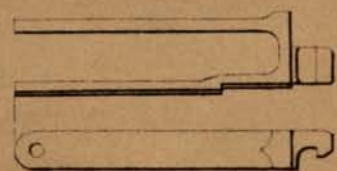


Fig. 15. Battant de crosse à pivot tournant.



Tenon à fourche.



PL. XII^{bis}

Revolver modèle 1874.

Echelle $\frac{1}{2}$.

Revolver modèle 1873.

Fig 1 Vue du côté droit.
(les plaquettes enlevées le chien au cran de sûreté).

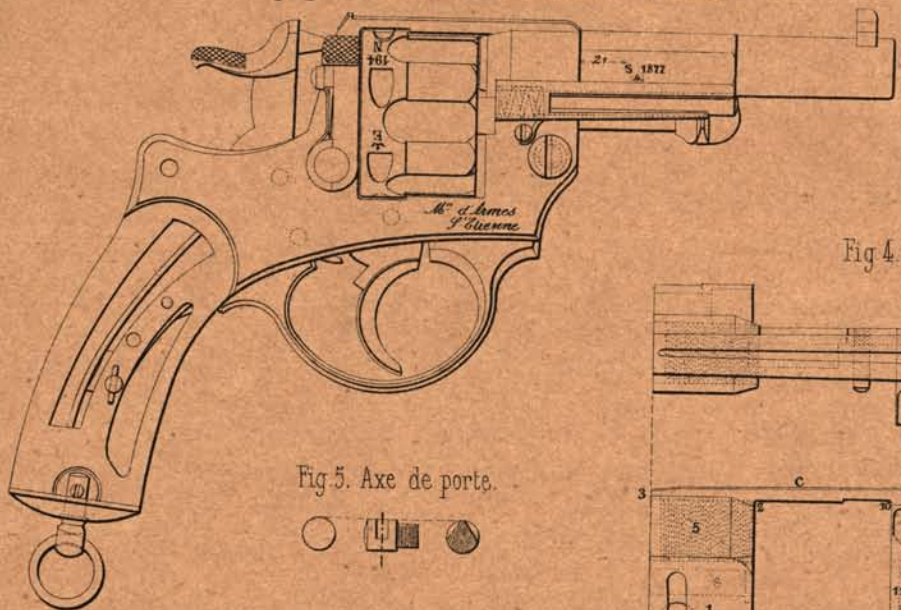


Fig 2 Vue d'ensemble du mécanisme.
(la plaque de recouvrement et la plaquette gauche enlevées).

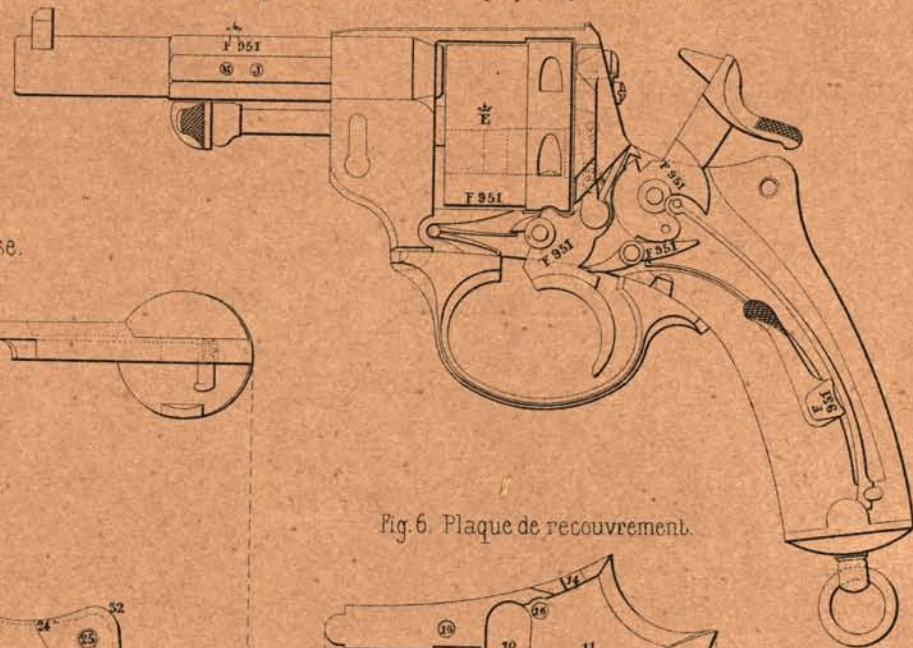


Fig 4. Carcasse.

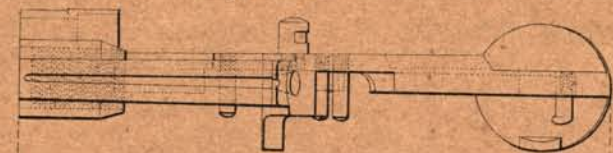


Fig 5. Axe de porte.



Fig 3. Canon.

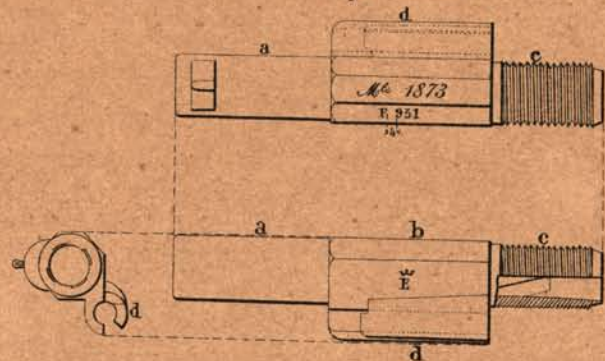


Fig 6. Plaque de recouvrement.

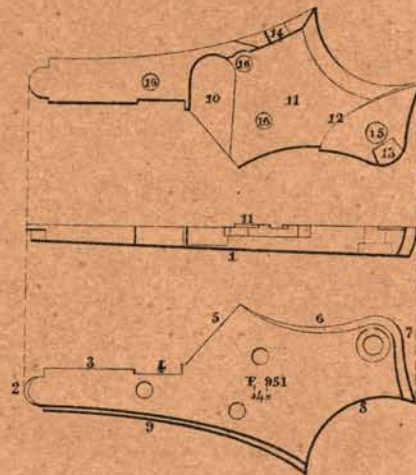
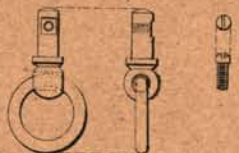


Fig 7. Vis de plaque de recouvrement.



Fig 8. Anneau de calotte. Pivot d'anneau de calotte et sa vis.



Echelle (1/2)

Fig 1. Barillet.

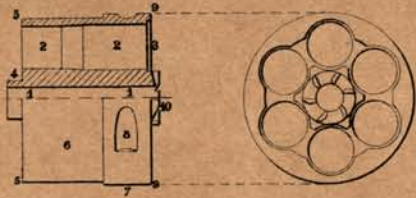


Fig 2. Axe du barillet.

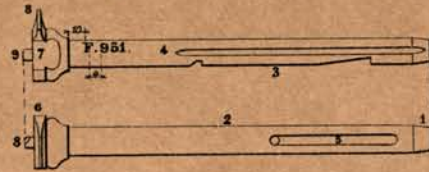


Fig 3. Ressort d'axe du barillet



Fig 4. Baguette.

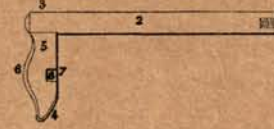


Fig 5. Ressort de baguette.



Fig 6. Vis de ressort de baguette.



Fig 7. Vis-arêteur de ressort de baguette.



Fig 8. Chien.

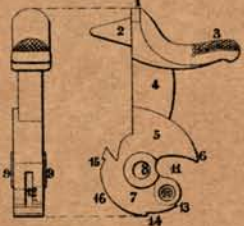


Fig 9. Chainette.



Fig 10. Vis de chainette.



Fig 11. Ressort de gâchette.

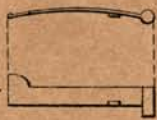


Fig 12. Gâchette.



Fig 13. Détente.

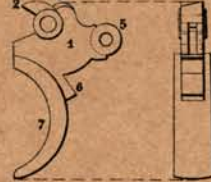


Fig 14. Ressort de détente.



Fig 15. Barrette.

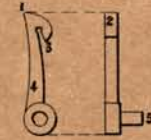


Fig 16. Ressort de barrette.



Fig 17. Mentonnet.

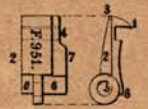


Fig 18. Grand ressort



Fig 21. Etouneau de grand ressort.

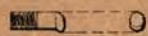


Fig 22. Pontet

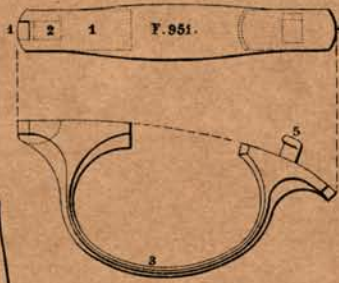


Fig 23. Bouton de poussoir



Fig 24. Ressort de poussoir



Fig 25. Poussoir



Fig 26. Porte

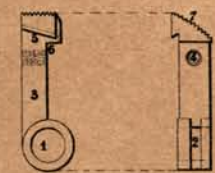


Fig 19. Clef de grand ressort.

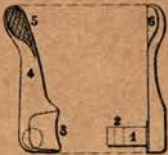


Fig 20. Goupille de clef de grand ressort.



Fig 29. Plaquette droite.

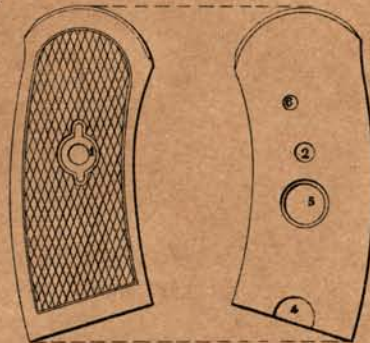


Fig 31. Vis de monture et sa rosette.



Fig 30. Plaquette gauche.

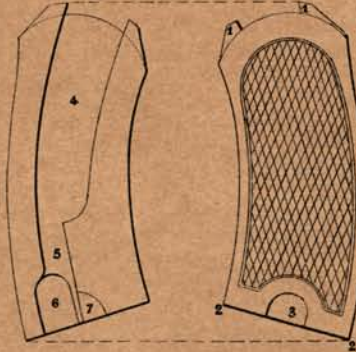


Fig 27. Ressort de porte.

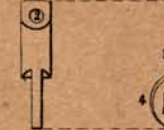


Fig 28. Vis de ressort de porte.



Echelle. (1/2).

Fig.1 Vue du côté droit, le barillet rabattu.

Fig.2 Vue du côté gauche, la platine à découvert.

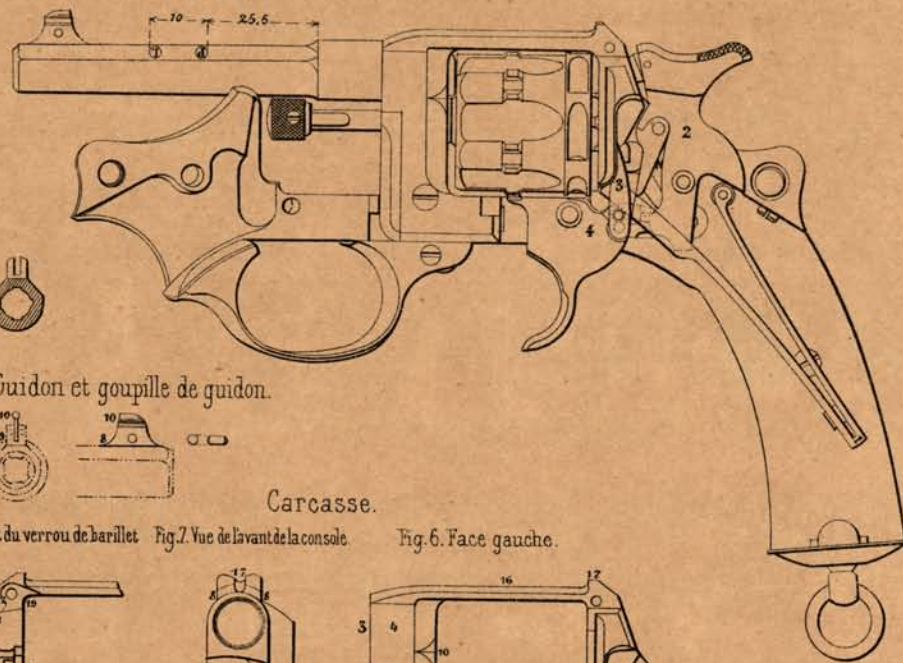
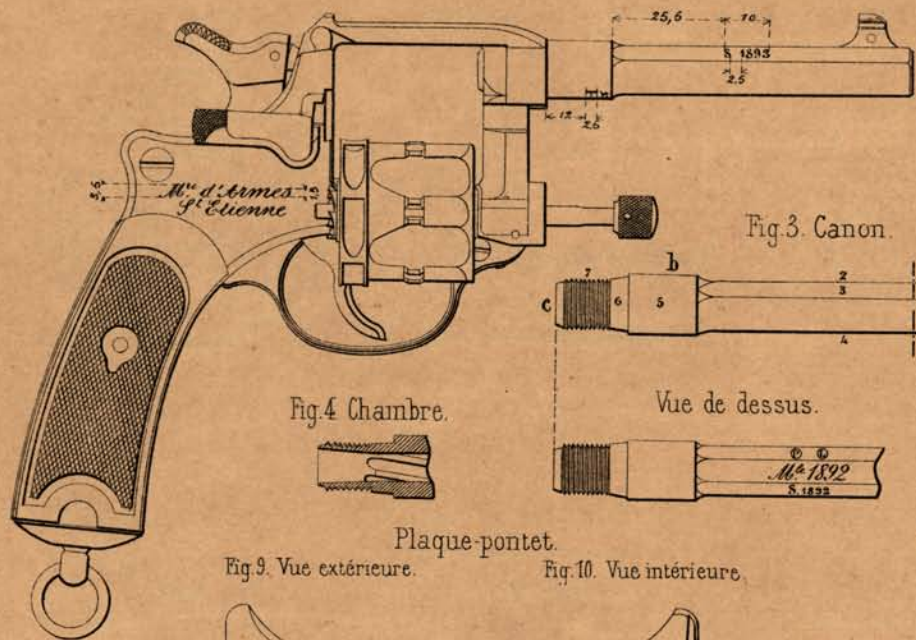


Fig.3. Canon.

Fig.5. Guidon et goupille de guidon.

Fig.4 Chambre.

Vue de dessus.

Carcasse.

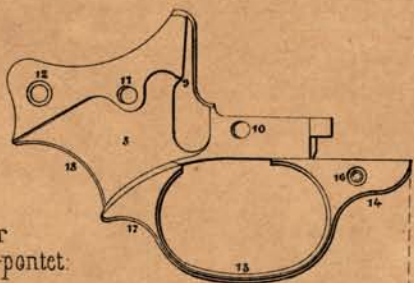
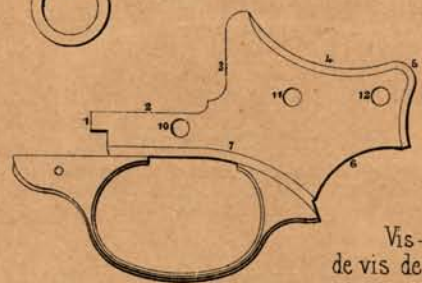
Fig.5. Logement du verrou de barillet Fig.7. Vue de l'avant de la console.

Fig.6. Face gauche.

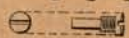
Plaque-pontet.

Fig.9. Vue extérieure.

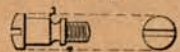
Fig.10. Vue intérieure.



Vis-arrière de vis de plaque-pontet.



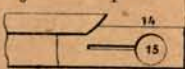
Vis de plaque-pontet.



Vis de pivot de plaque-pontet.



Logement du pivot.



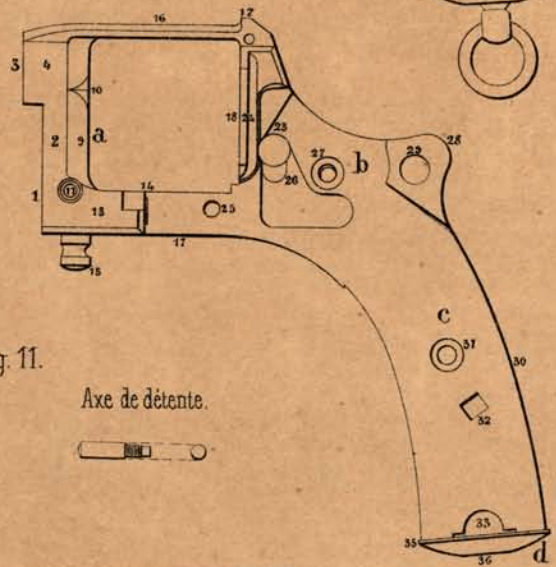
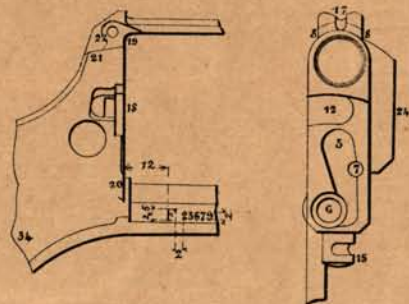
Axe de chien.



Axe de détente.



Fig.11.



Détails du barillet. ($\frac{1}{4}$).

Fig.1. Barillet

Vue de l'avant.

Vue de côté
et coupe par l'axe d'une chambre.

Vue de l'arrière.

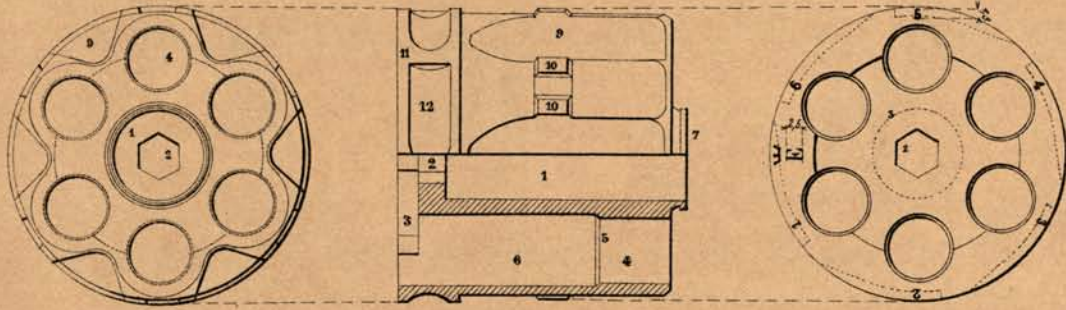


Fig.3. Tige d'extracteur.

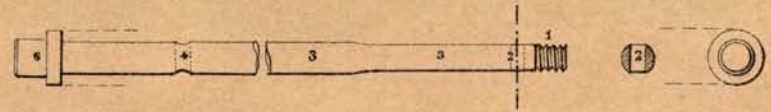


Fig.5. Tube.



Fig.7. Poussoir.

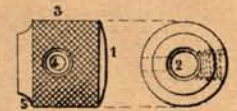


Fig.2. Extracteur.

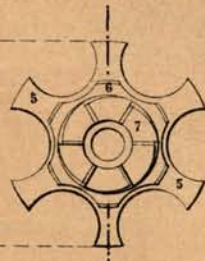
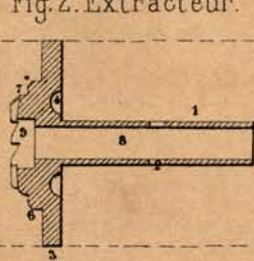
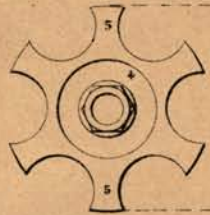


Fig.4. Goupille
d'extracteur.



Fig.6. Ressort d'extracteur.



Fig.8. Vis-goupille
de poussoir.

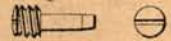


Fig.9 Ressort d'axe de barillet.

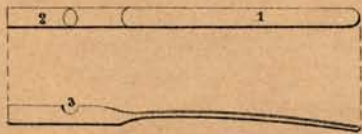


Fig.11 Support de barillet.

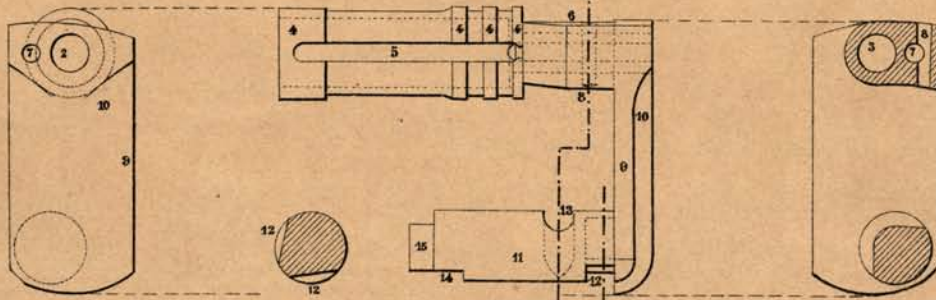


Fig.10. Goupille
de ressort d'axe de barillet.

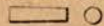


Fig.12. Ressort de
support de barillet.

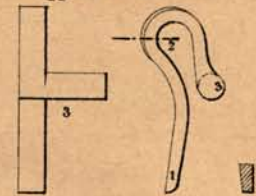
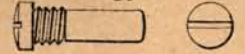


Fig.13. Vis-arrêt
de support.



Cuirasse de cuirassier M^{le} 1855.

Fig. 1. Cuirasse garnie ($\frac{1}{8}$).

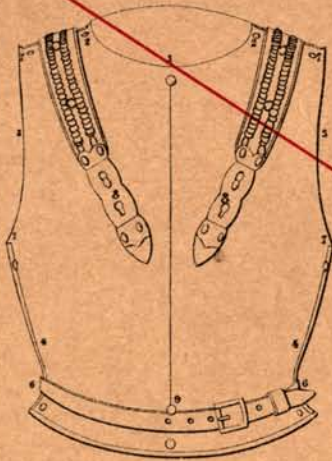


Fig. 2. Vue intérieure du dos. Marques. ($\frac{1}{8}$).

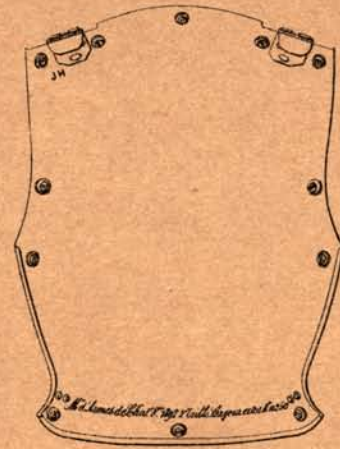


Fig. 3. Grande courroie de ceinture ($\frac{1}{4}$).



Fig. 4. Petite courroie de ceinture ($\frac{1}{4}$).



Fig. 5. Bretelle ($\frac{1}{4}$).

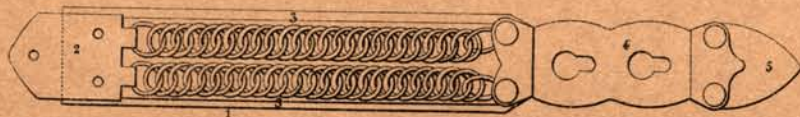


Fig. 8. Bouton de bretelle ($\frac{1}{4}$).

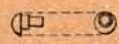


Fig. 10. Clou rivé.



Fig. 9. Bouton de ceinture ($\frac{1}{4}$).

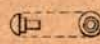


Fig. 11. Rosette.



Fig. 6. Boucle ($\frac{1}{4}$).

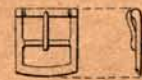
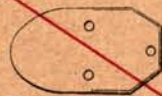


Fig. 7. Support de plastron ($\frac{1}{4}$).



PL. XXV.

Nécessaire d'armes M^{le} 1874. (1/2).

Fig. 1. Trousse.



Fig. 2. Tampon et goupilles.

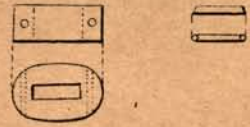


Fig. 3. Huilier.



Fig. 4. Boîte de nécessaire.



Fig. 5. Lame de tournevis.



Fig. 6. Curette-spatule.

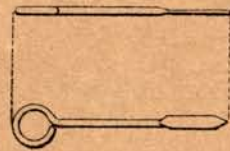


Fig. 7. Fond.



Fig. 8. Vis bouchon et sa rondelle.

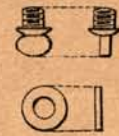


Fig. 9. Corps de boîte avec fond.

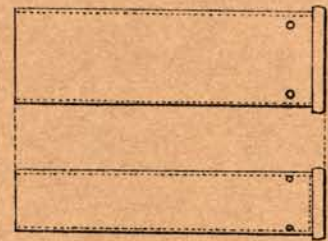


Fig. 10. Baguette en bois pour revolver M^{le} 1873 et 1874.

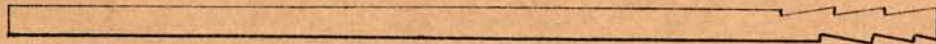


Fig. 11. Ficelle avec chiffon monté.



Accessoires du revolver M^{le} 1892. (1/2).

Fig. 12. Baguette pour revolver M^{le} 1892.

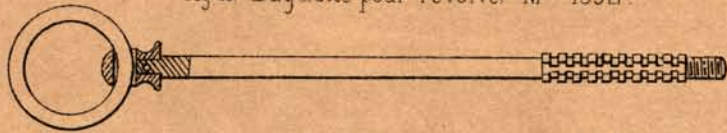


Fig. 13. Ecouvillon pour revolver.



Fig. 14. Douille.

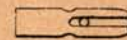


Fig. 17. Remontage d'un écouvillon.

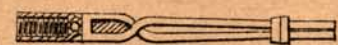


Fig. 15. Tournevis pour revolver M^{le} 1892.

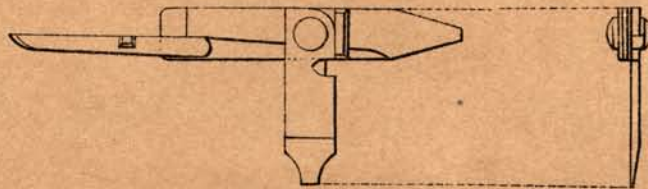
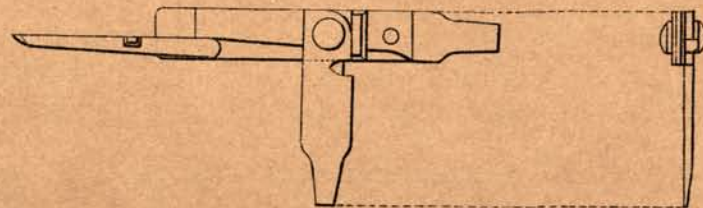


Fig. 16. Tournevis mixte M^{le} 1898.



Nécessaires de chambre M^{le} 1895 et M^{le} 1896.

Echelle 4.

Fig.1. Baguette de graissage.

M^{le} 1895 longr. = 240 (pour fusil M^{le} 1886.)
M^{le} 1896 longr. = 500 (pour armes courtes de 8 m.m.)

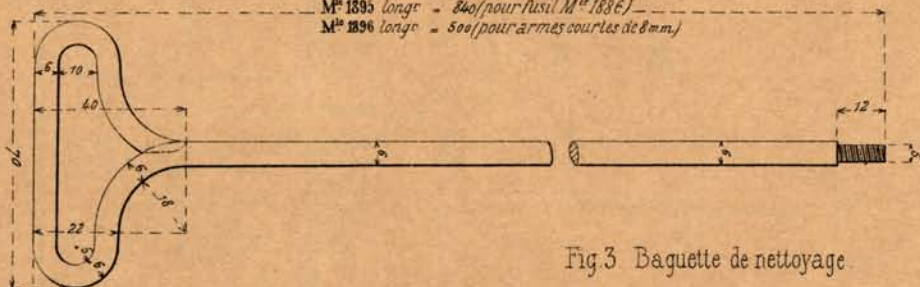


Fig.2. Ecouvillon.

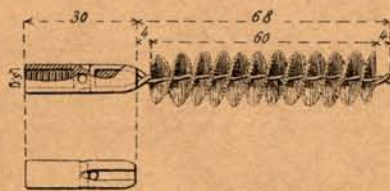


Fig.4. Tournevis-chasseur.

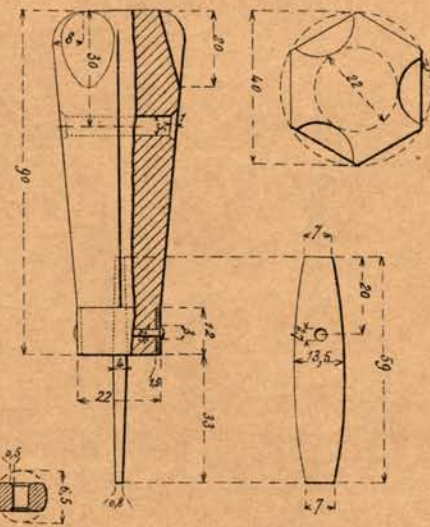
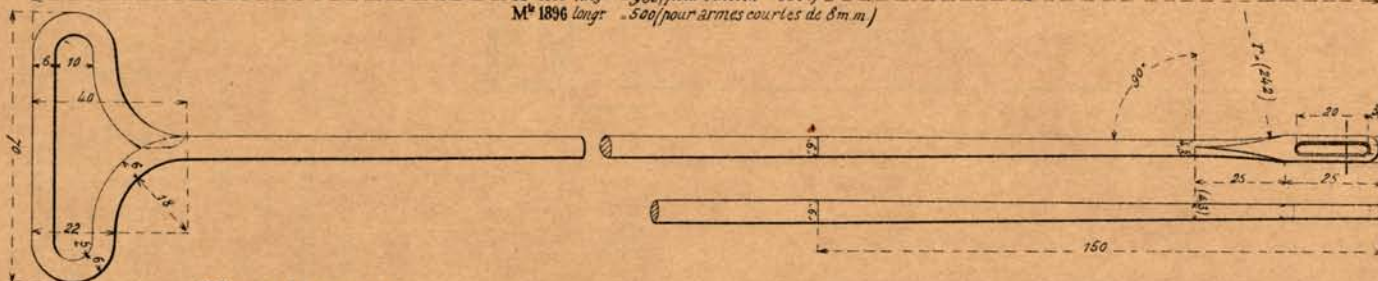


Fig.3. Baguette de nettoyage.

M^{le} 1895 longr. = 930 (pour fusil M^{le} 1886.)
M^{le} 1896 longr. = 500 (pour armes courtes de 8 m.m.)



Numérotage.

Fig.5.

Baquettes.

(1/4).

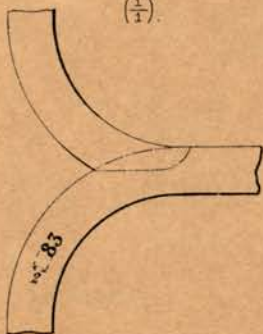


Fig.6.

Tournevis.



Réparations des baguettes.

Fig.8. Baguette de graissage. (+).

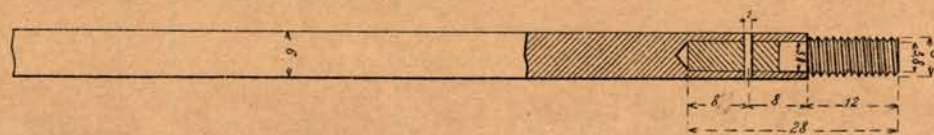


Fig.7. Baguette de nettoyage. (+).

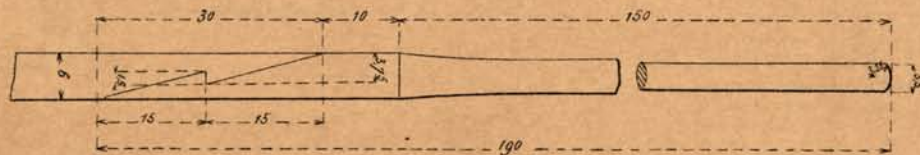


Fig.9.

Miroir de pointage.

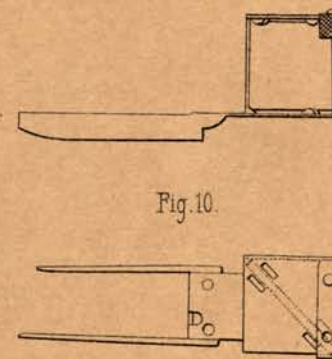


Fig. 1. Tourne à gauche pour canon. ($\frac{1}{4}$)

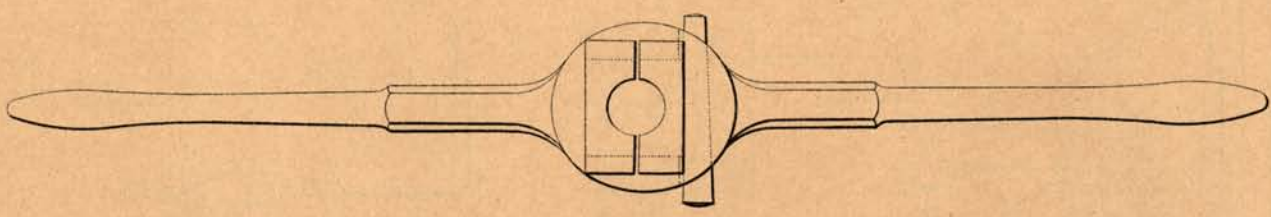
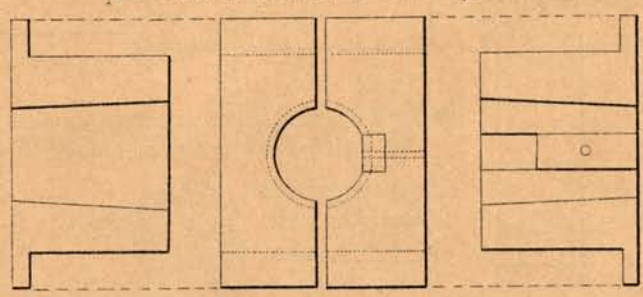


Fig. 2. Coussinets de tourne à gauche:
pour canons de carabine et de mousqueton. ($\frac{1}{2}$)



pour canon de fusils.

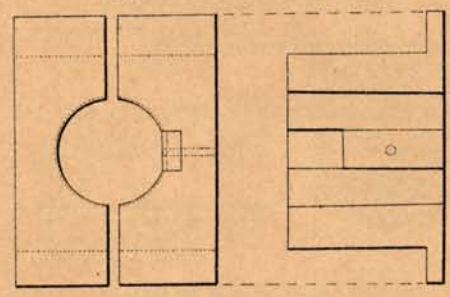


Fig. 3. Presse à semelle. ($\frac{1}{4}$)

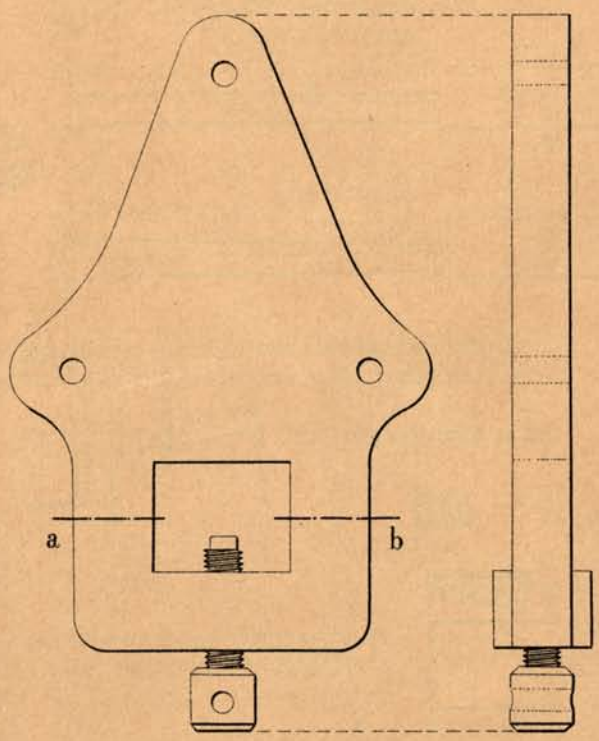


Fig. 4. Coussinets de presse. ($\frac{1}{2}$)

pour carabine et mousqueton.

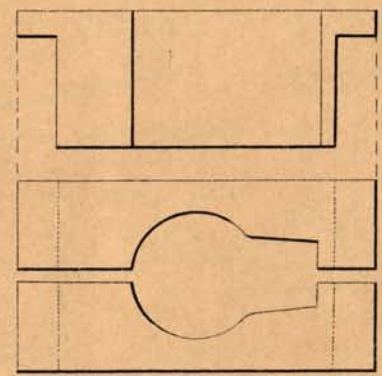


Fig. 5. pour fusils. ($\frac{1}{2}$)

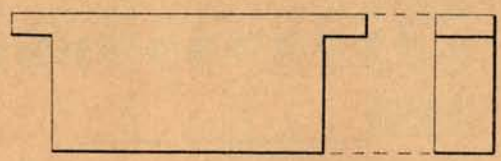


Fig. 6. Déculassage d'une carabine ou d'un mousqueton.

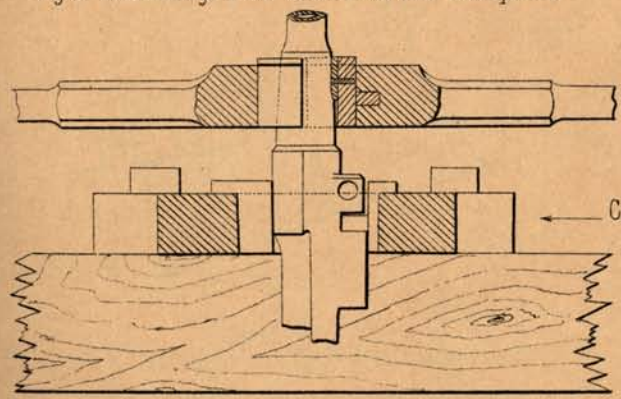
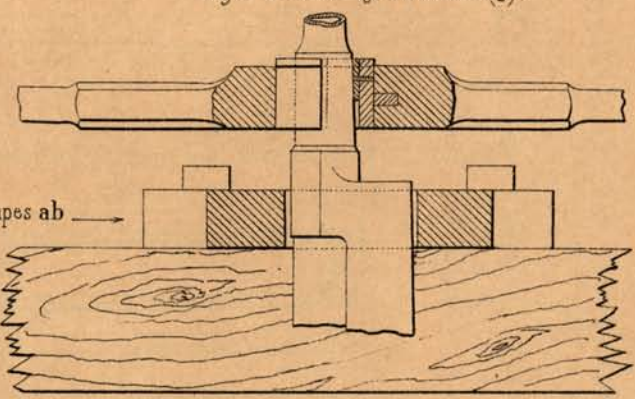


Fig. 7. Déculassage d'un fusil. ($\frac{1}{2}$)



Revolvers M^{les} 1873 et 1874.

Fig. 1. Guidon du Revolver M^{le} 1873.
Remplacement du grain d'orge. (1/2).

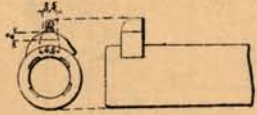


Fig. 3.
Pontet du Revolver M^{le} 1873
Remplacement du T. (1/2).

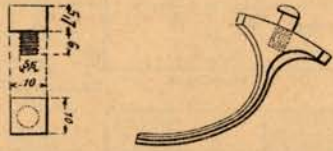
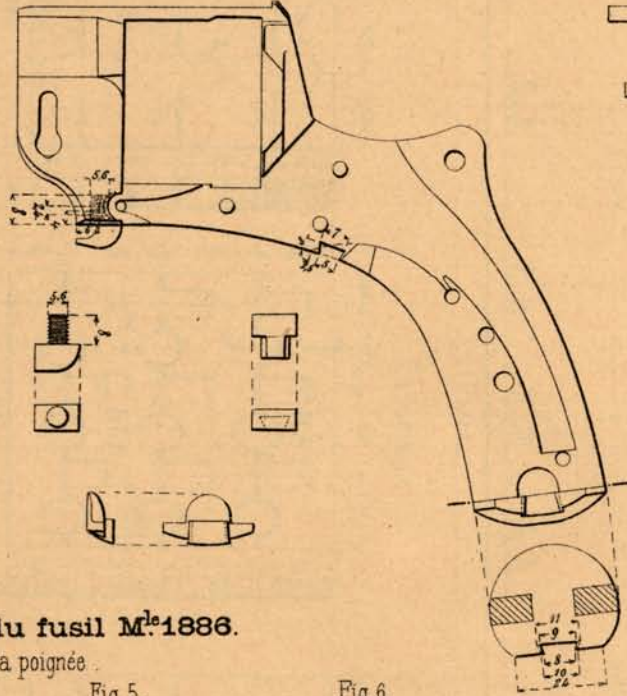
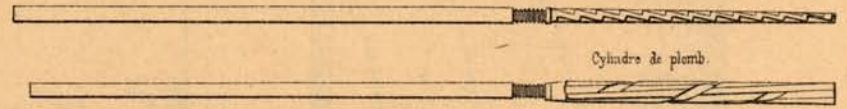


Fig. 2. Carcasse du Revolver M^{le} 1873. (1/2).
Remplacement du crochet à bascule, de l'épaule-
ment pour le T du pontet et de l'oreille latérale de calotte.



Revolvers M^{les} 1873, 1874 et 1892.

Fig. 8. Tringle pour polir les chambres du barillet
au cylindre de plomb. (1/2).



Revolver M^{le} 1892.

Fig. 9. Pièce rapportée à l'épaule-
ment d'arrêt de la porte. (1/2).

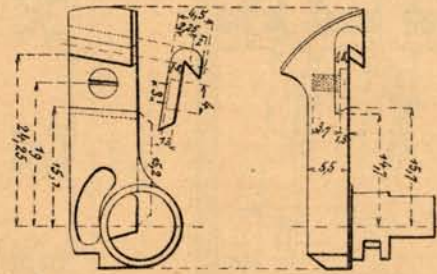
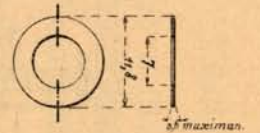


Fig. 10.
Rondelle pour le réglage
de la feuillure. (1/2).



Epée baïonnette du fusil M^{le} 1886.

Ajustage de la poignée.

Fig. 4.
Etampes
pour resserrer la poignée. (1/2).

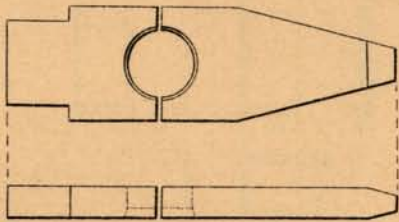


Fig. 5.
Fraises à rectifier
les trous de poignée. (1/2).

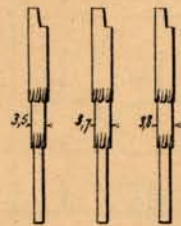


Fig. 6.
Fraise à rectifier
la tranche de
l'emplacement
de la virole. (1/2).

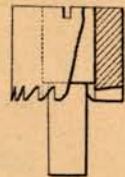
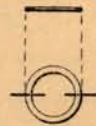
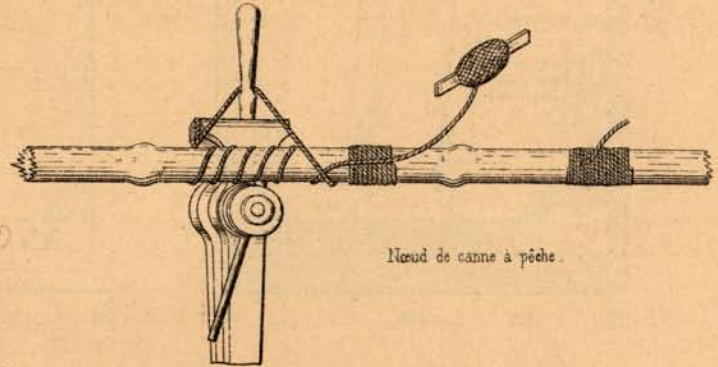


Fig. 7.
Disque en laiton
(1/2)



Lance M^{le} 1890.

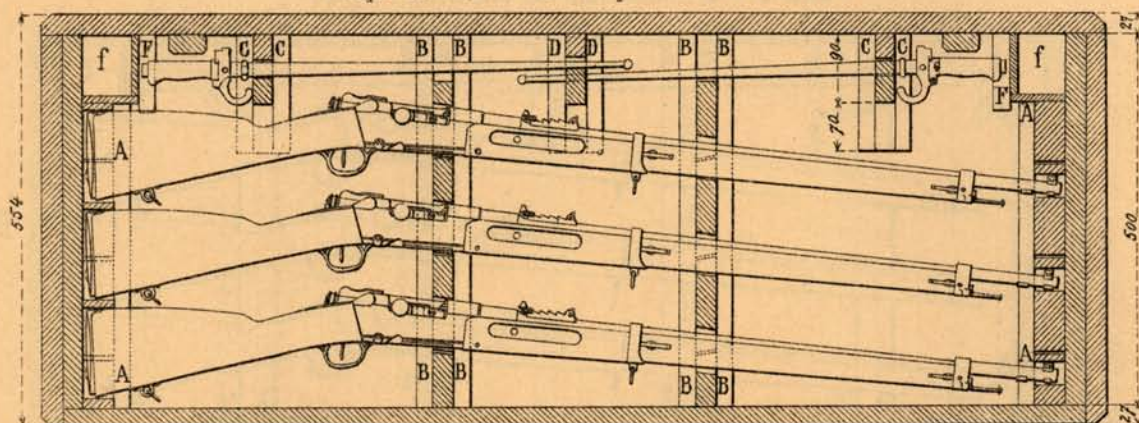
Fig. 11. Réparation de la hampe.



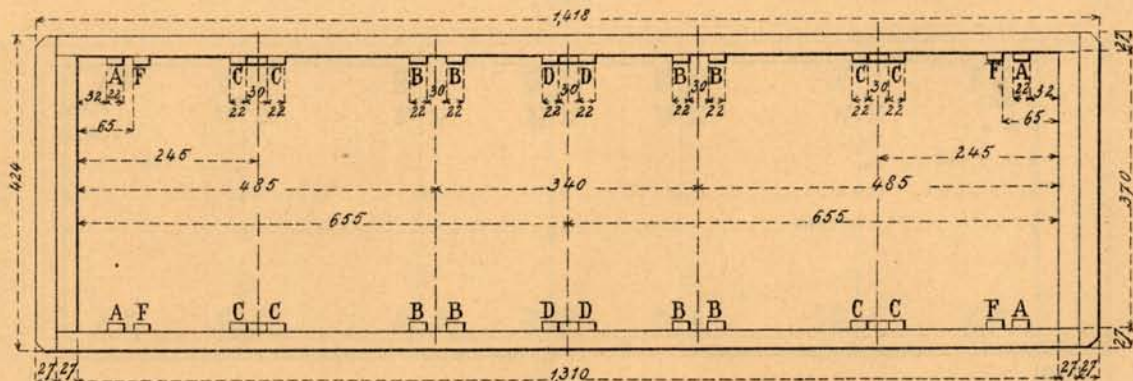
Nœud de canne à pêche.

Echelle (1/10).

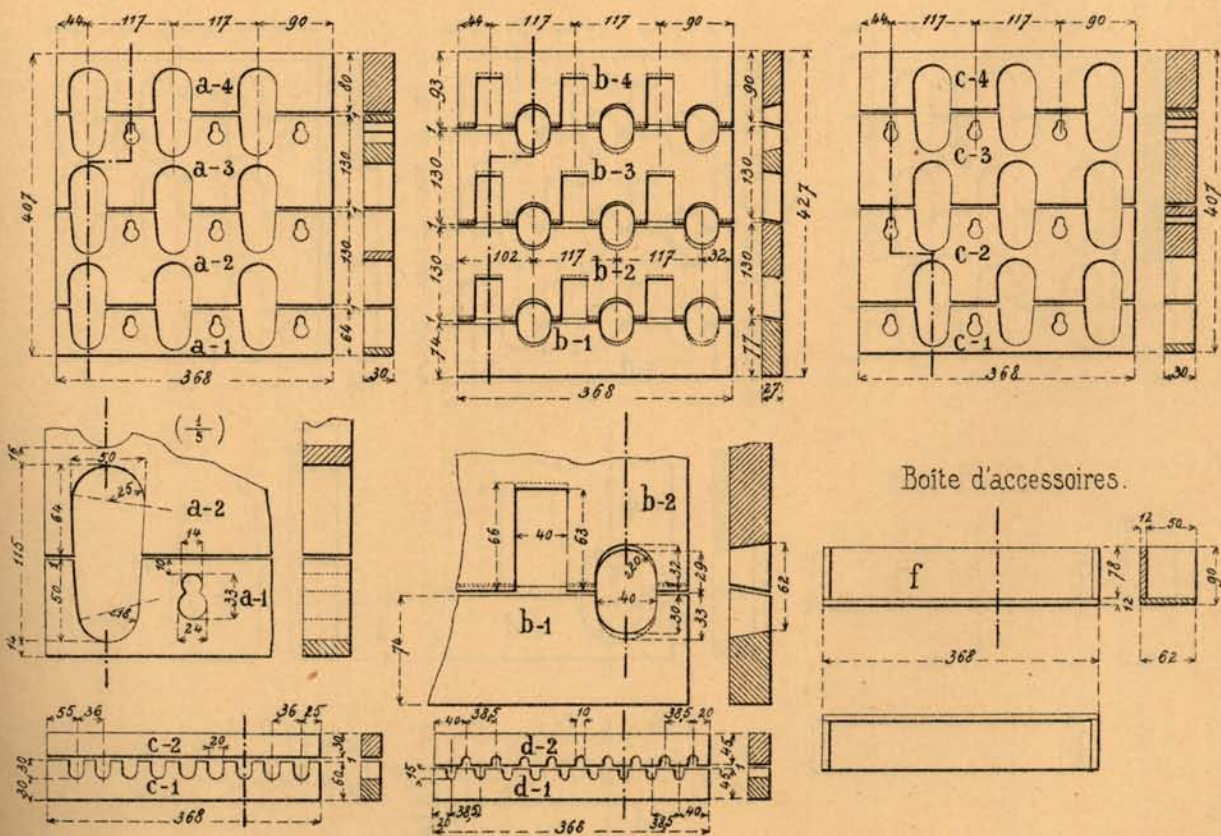
Coupe montrant la disposition des armes.



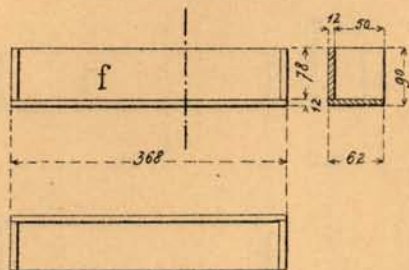
Plan.



Tasseaux.



Boîte d'accessoires.

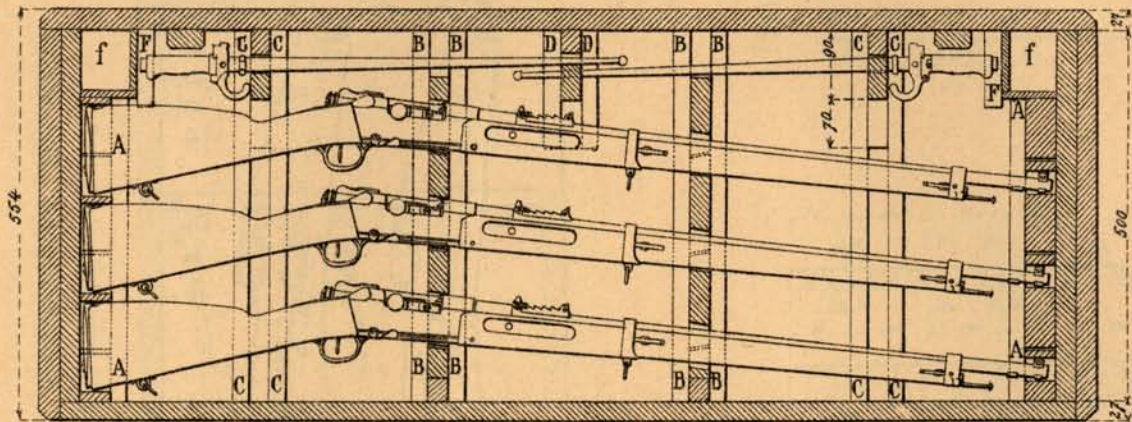


CAISSE TRANSFORMÉE
 POUR FUSILS M^{LE} 1886 ET M^{LE} 1886_M_93.

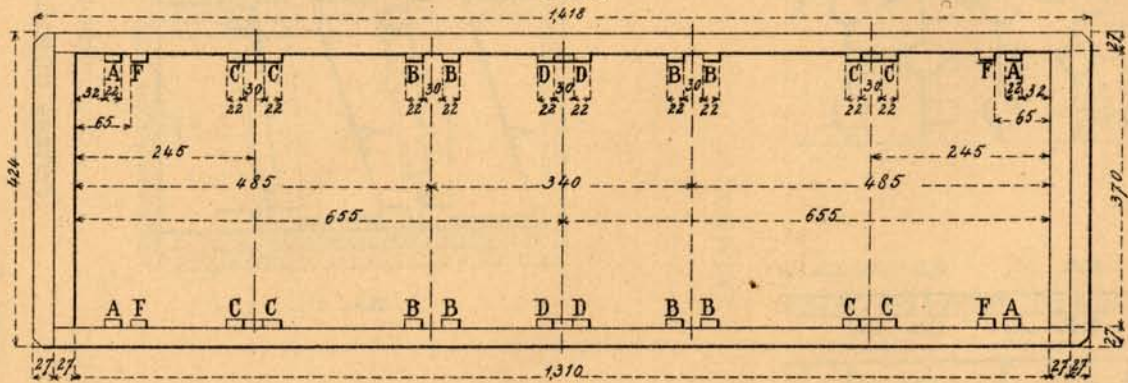
PL. XXXII.

Echelle (1/10).

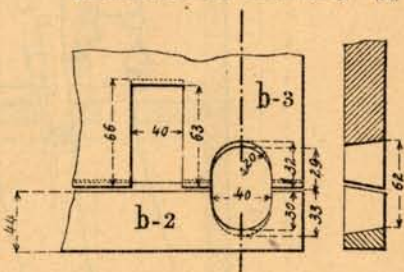
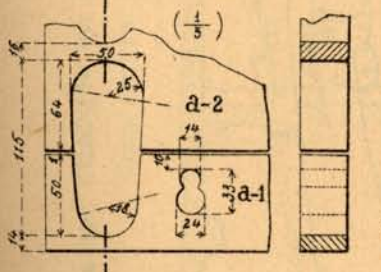
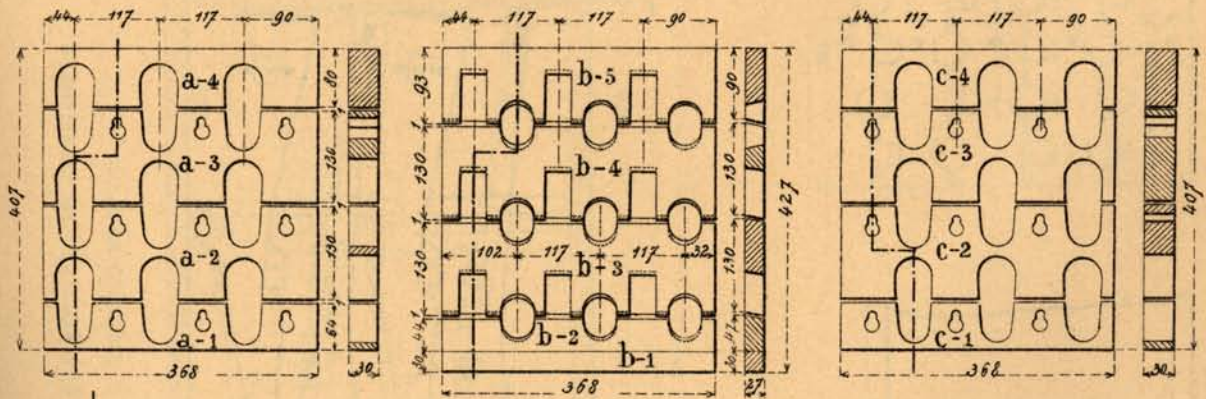
Coupe montrant la disposition des armes.



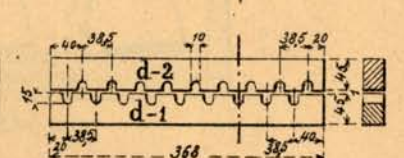
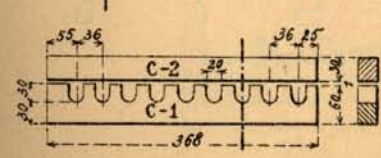
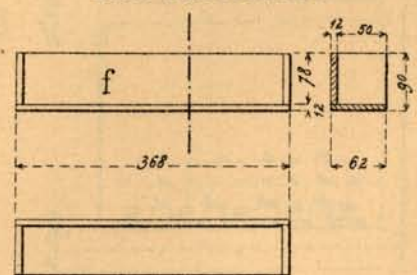
Plan.



Tasseaux.



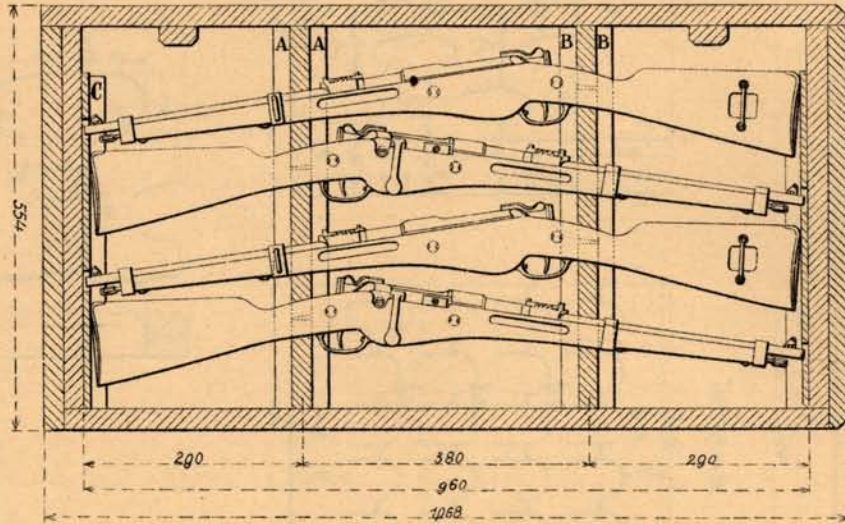
Boîte d'accessoires.



Echelle 1/10

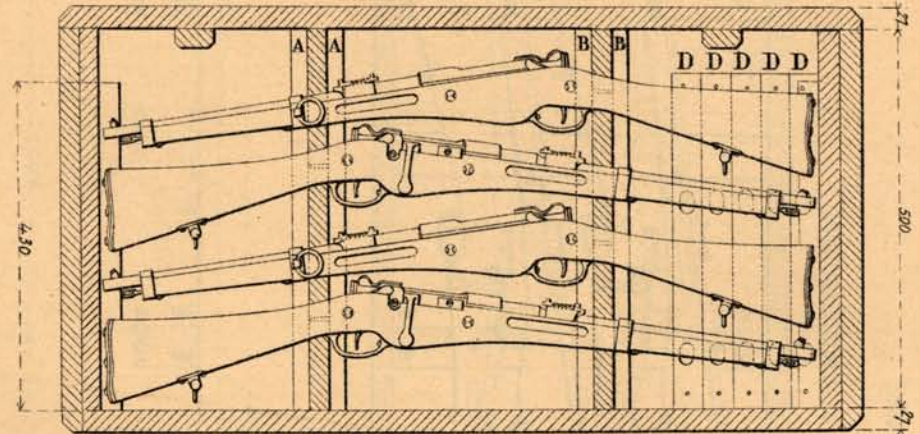
Caisse chargée en carabines de cavalerie.

Coupe montrant la disposition des armes.



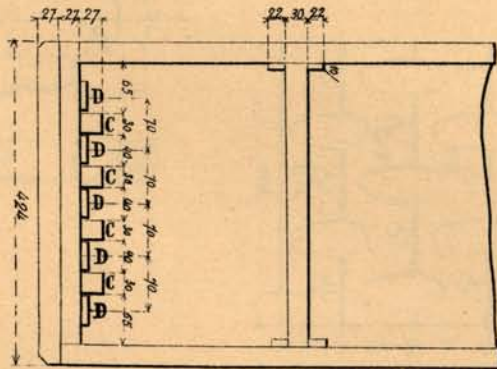
Caisse chargée en carabines de cuirassier.

Coupe montrant la disposition des armes.

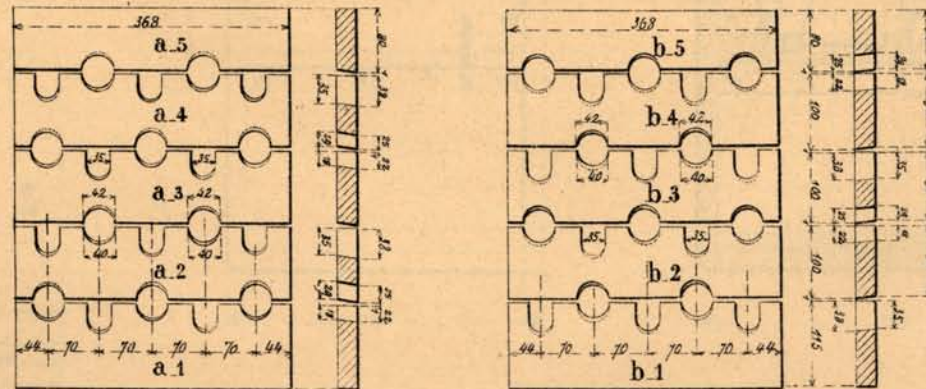


PL. XXXIII

Plan



Tasseaux.



Planchette.

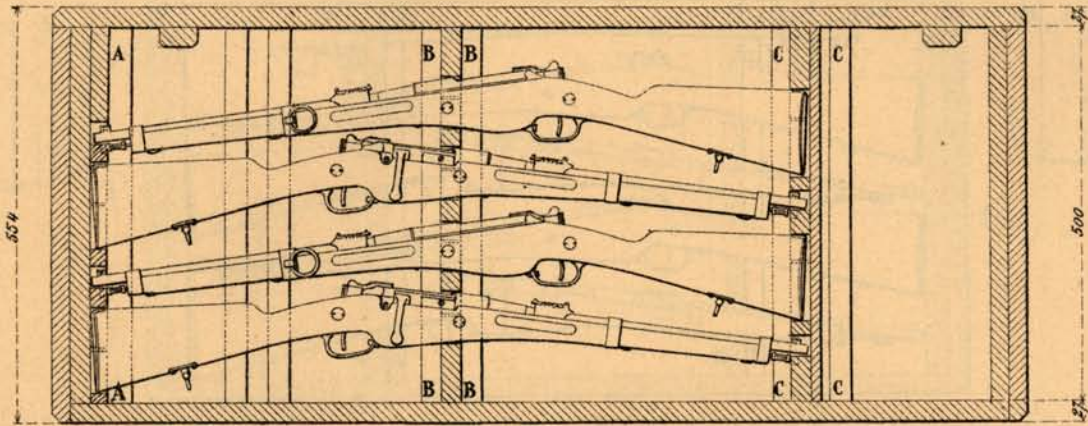


CAISSE TRANSFORMÉE POUR CARABINES DE CAVALERIE ET DE CUIRASSIER M^{LE} 1890.

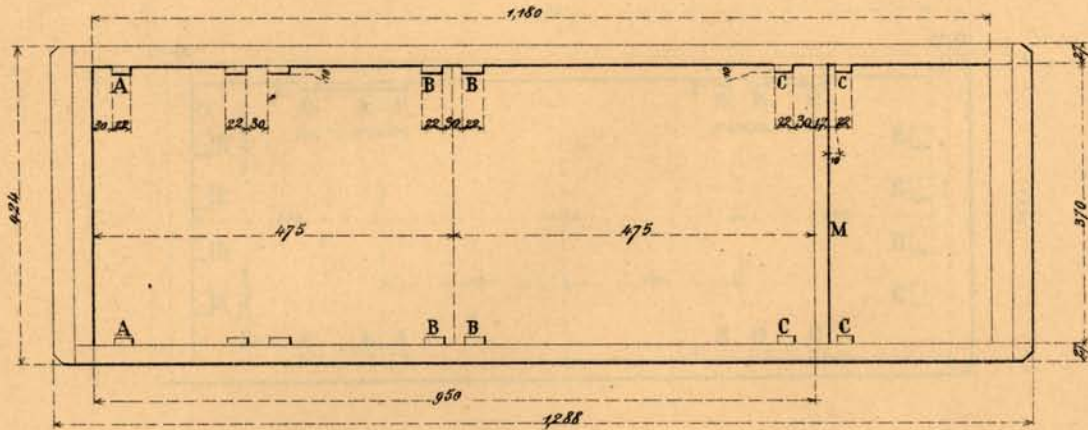
PL. XXXIV.

Echelle (1/5).

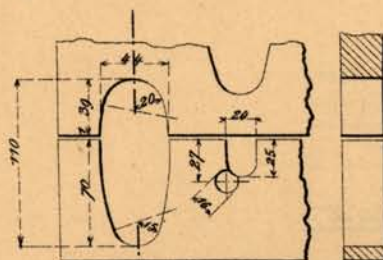
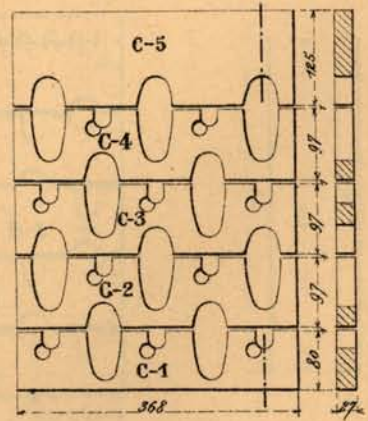
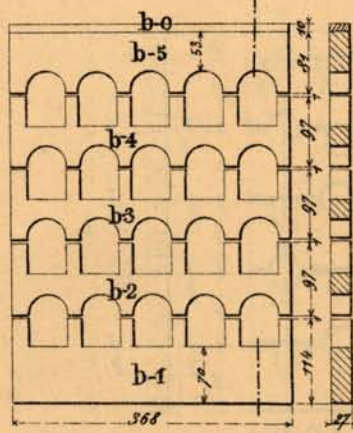
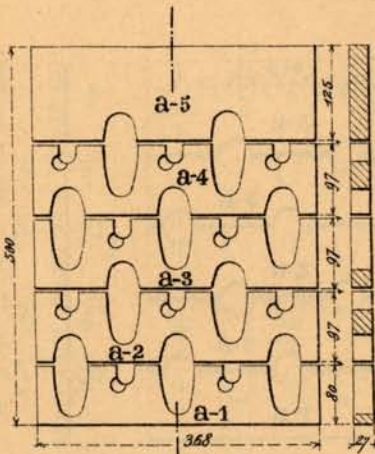
Coupe montrant la disposition des armes.



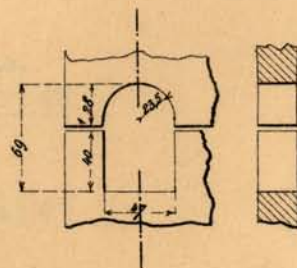
Plan.



Tasseaux.

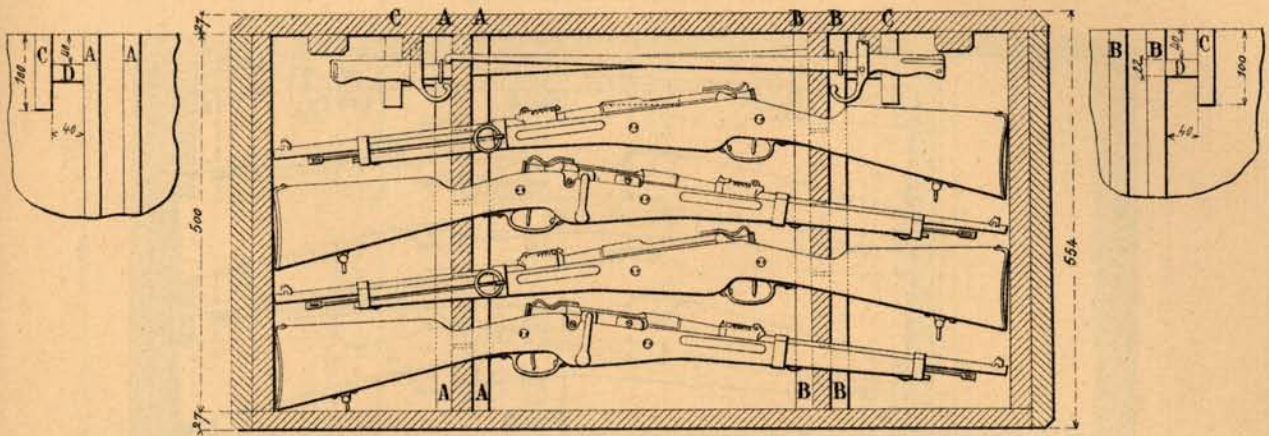


(1/5)

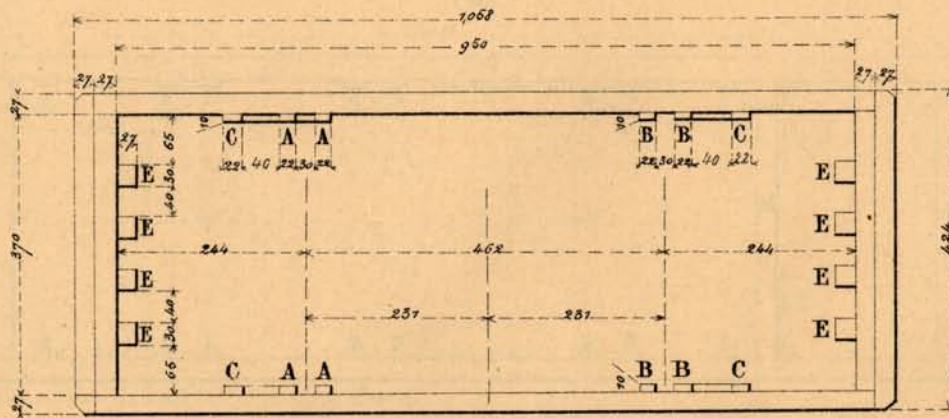


Echelle $\frac{1}{10}$

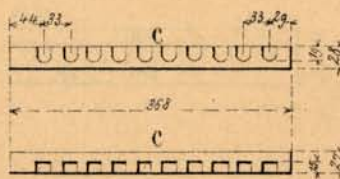
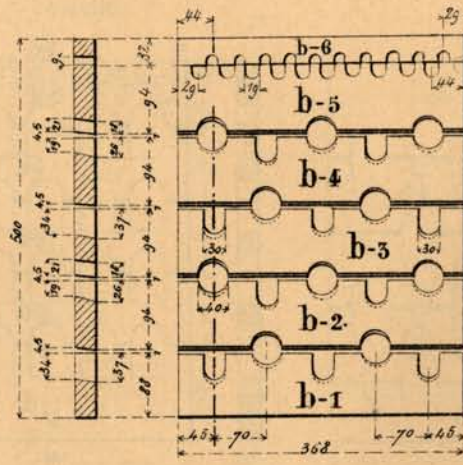
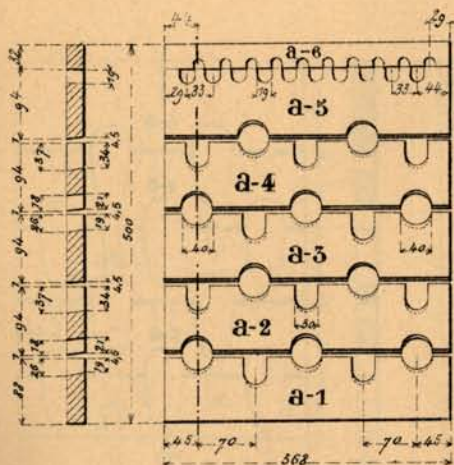
Coupe montrant la disposition des armes.



Plan.

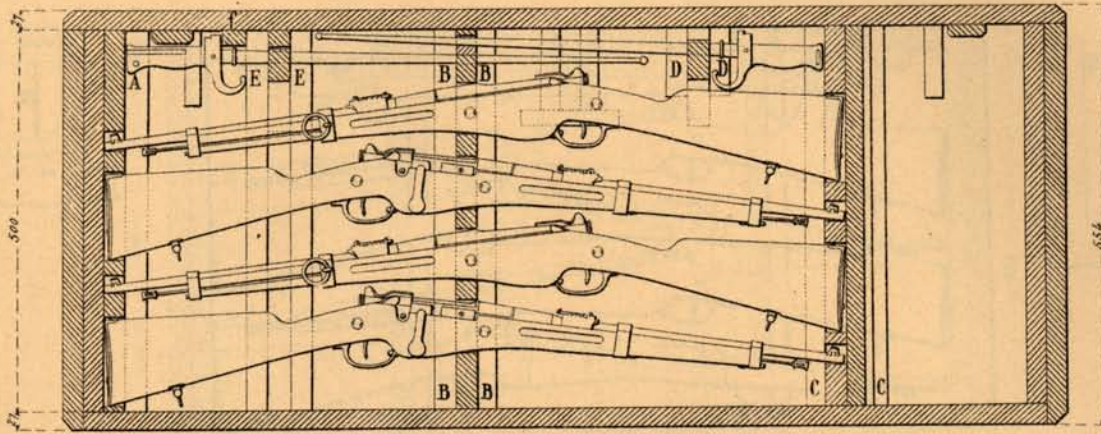


Tasseaux et planchettes.

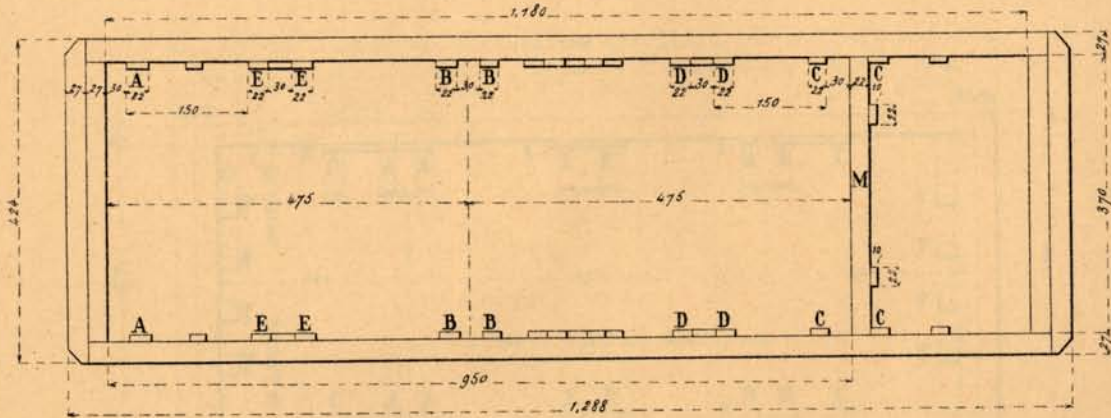


Echelle $\frac{1}{5}$.

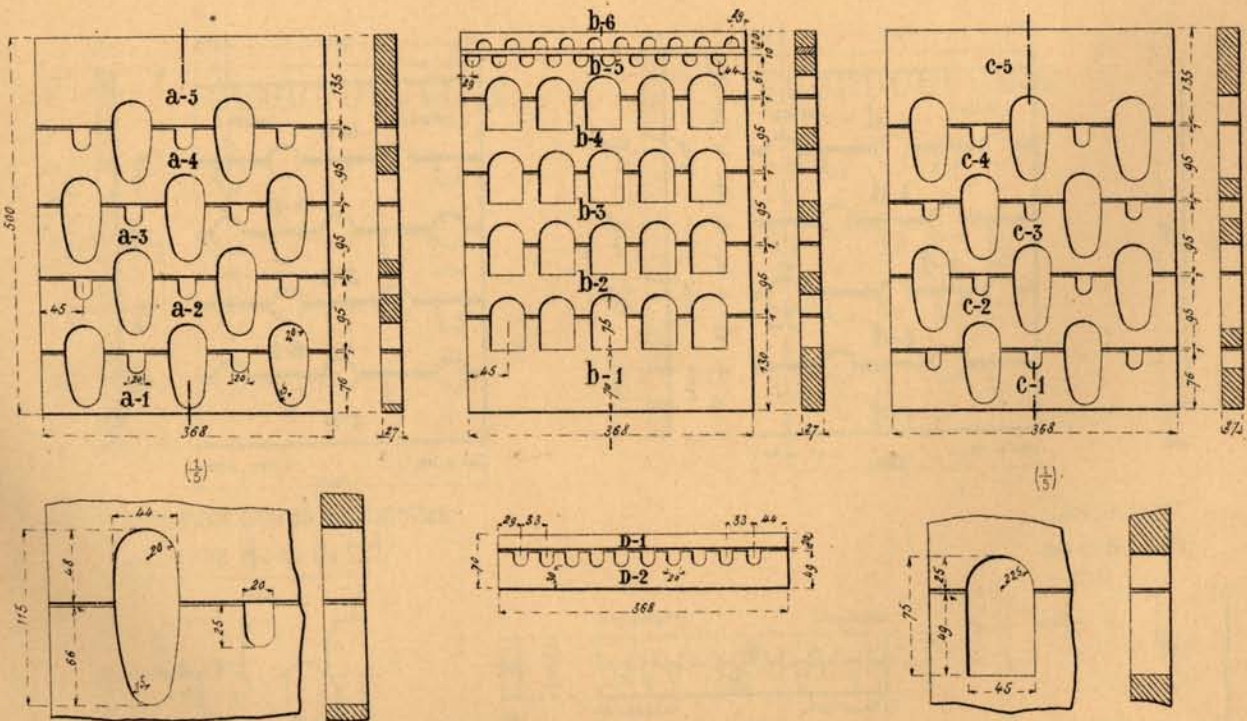
Coupe montrant la disposition des armes.



Plan



Tasseaux



CAISSE POUR REVOLVERS
M^{LE} 1873, M^{LE} 1874 ET M^{LE} 1892.

PL. XXXIX.

Echelle ($\frac{1}{10}$).

Fig. 1.
Disposition des tasseaux
pour les M^{les} 1892 et 1874.

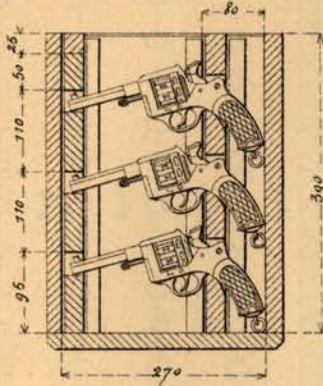


Fig. 2.
Disposition des tasseaux
pour le M^{le} 1873.

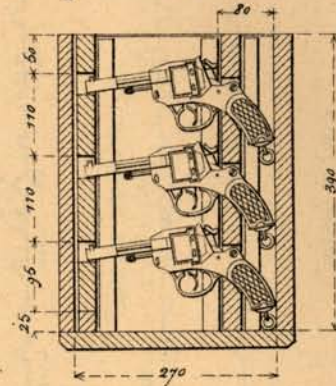
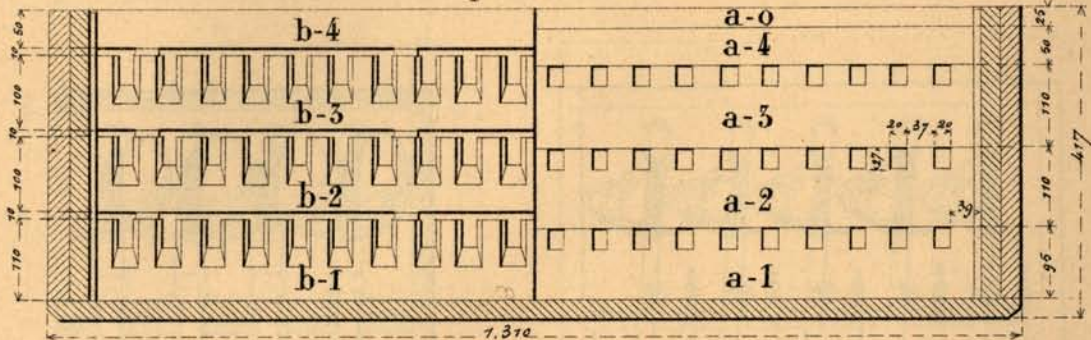
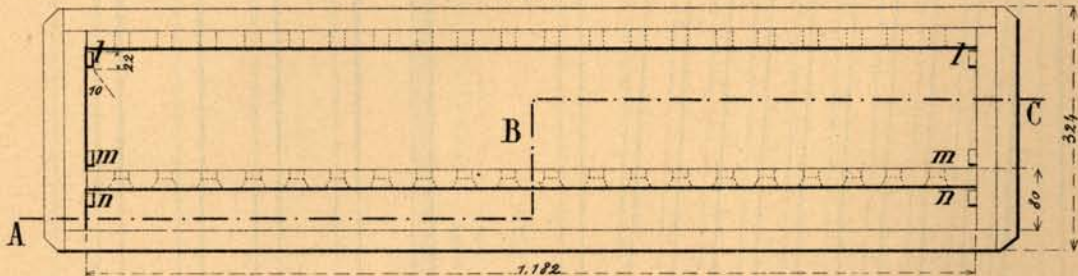


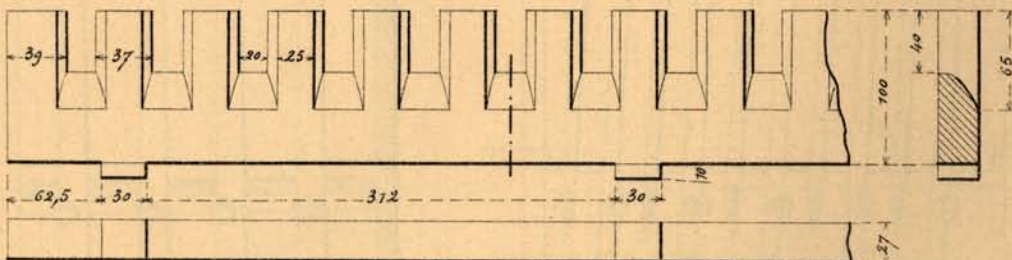
Fig. 3.
Caisse disposée pour les M^{les} 1892 et 1874.
Coupes suivant ABC.



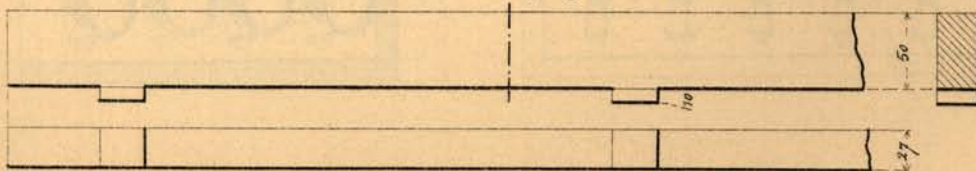
Plan.



Tasseau intermédiaire de poignées. ($\frac{1}{5}$).

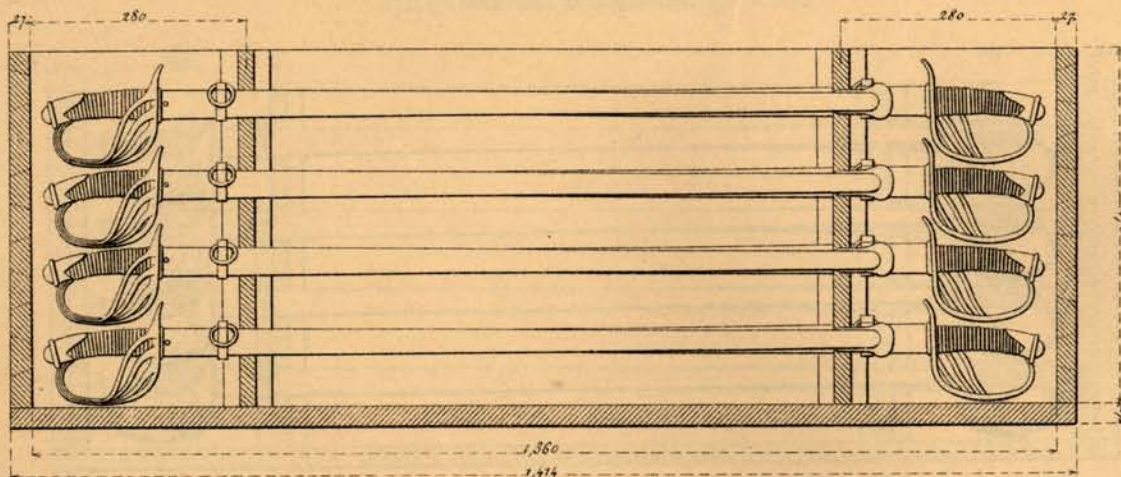


Tasseau de dessus de poignées. ($\frac{1}{5}$).

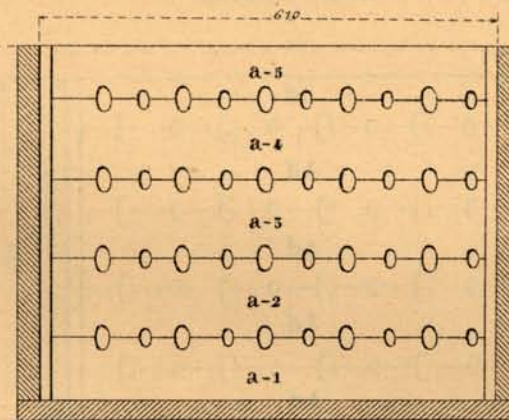


Echelle $\frac{1}{10}$.

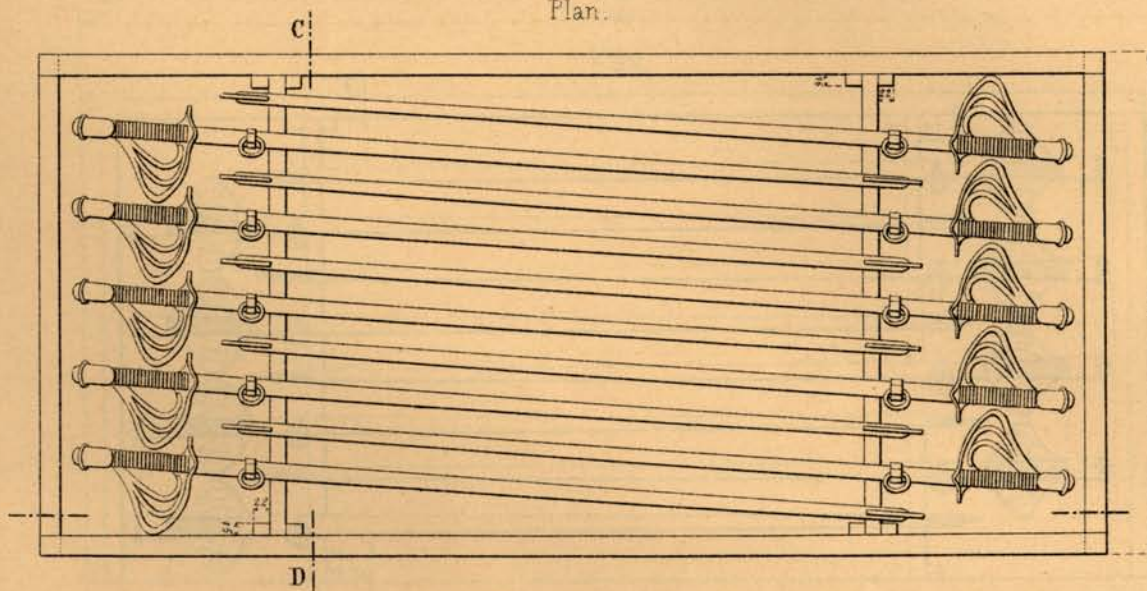
Coupe montrant la disposition des armes.



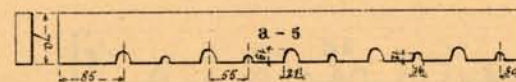
Coupe suivant CD.



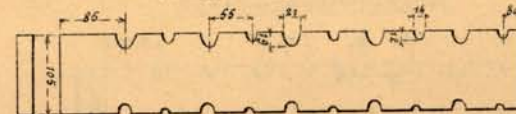
Plan.



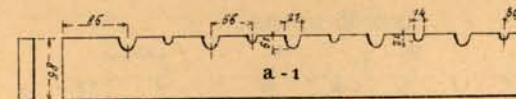
Tasseau de dessus.



Tasseaux intermédiaires.

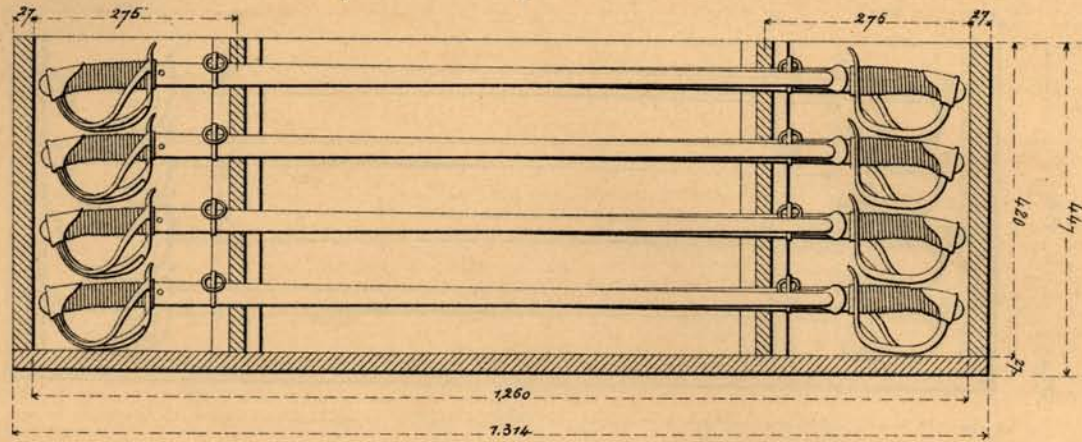


Tasseau de fond.

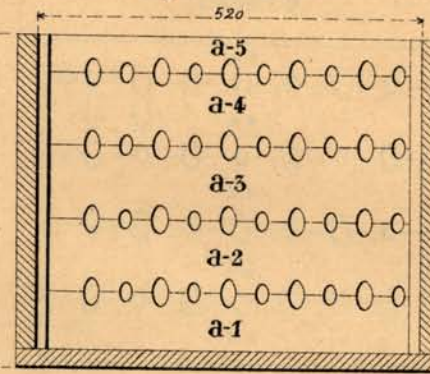


Echelle. $\frac{1}{10}$.

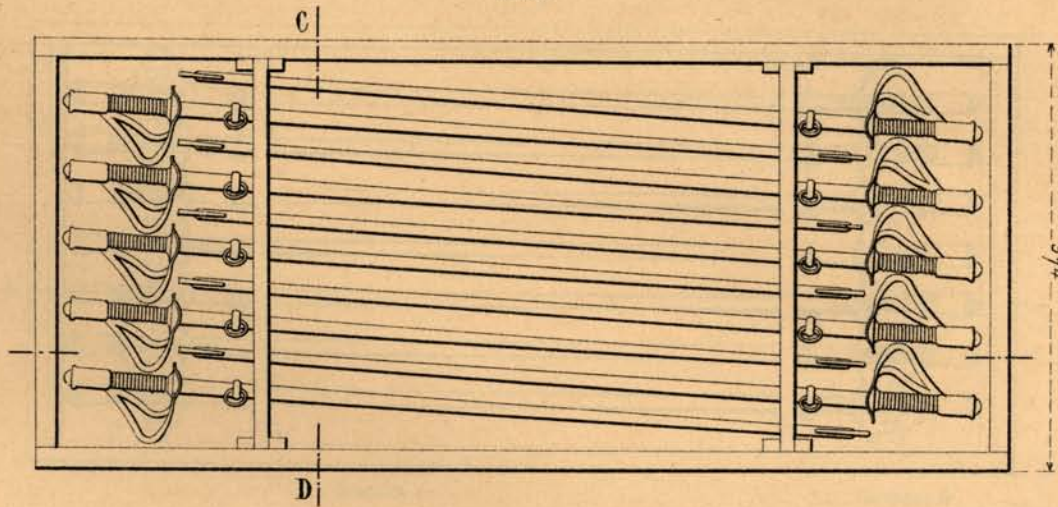
Coupe montrant la disposition des armes.



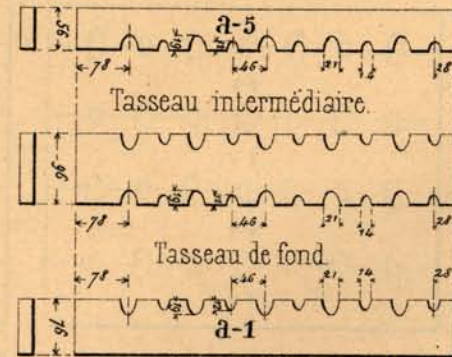
Coupe suivant CD.



Plan.

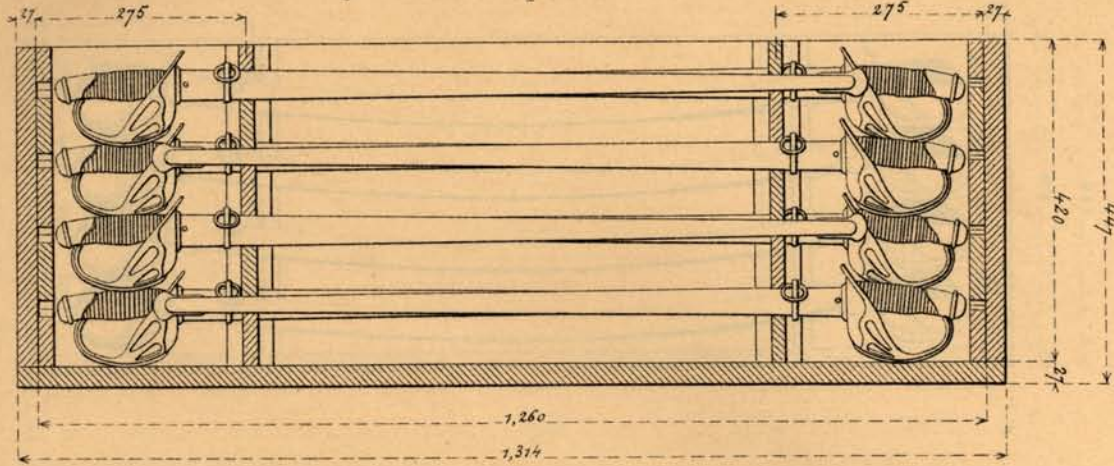


Tasseau de dessus.



Echelle ($\frac{1}{10}$)

Coupe montrant la disposition des armes.



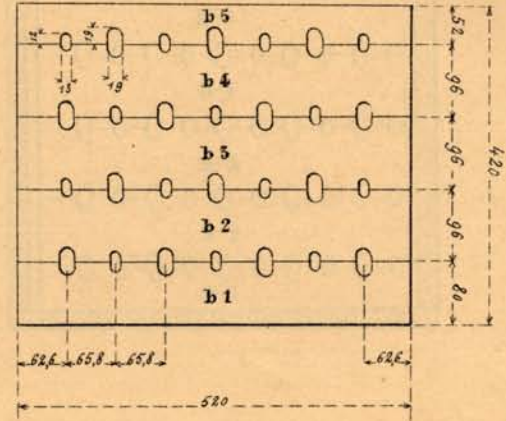
Plan.



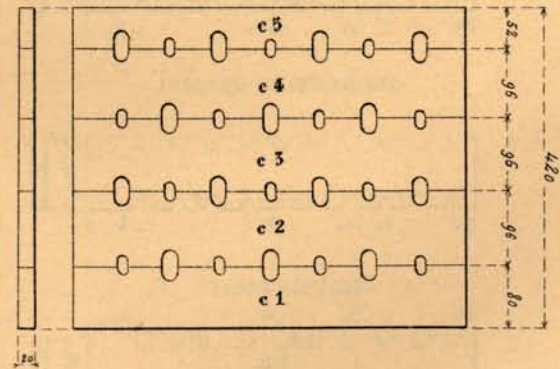
Tasseaux c.

Tasseaux B.

Tasseaux b.

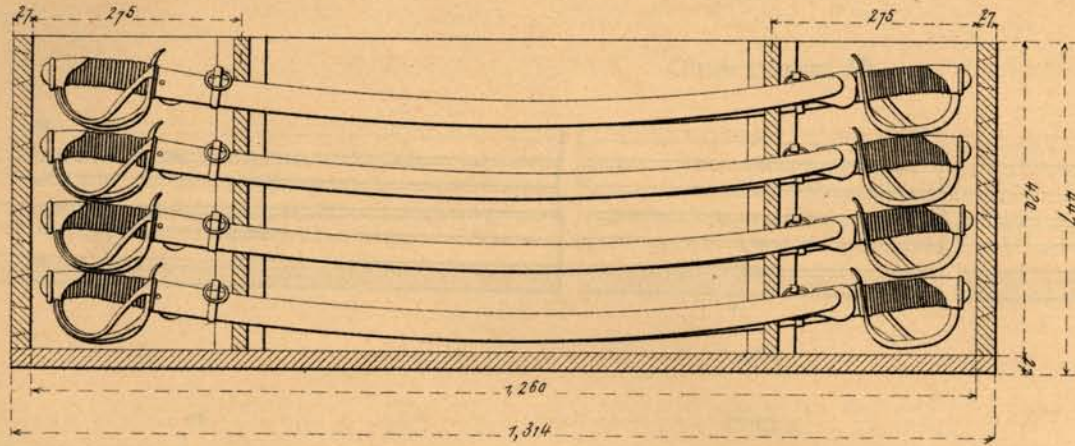


Tasseaux c.

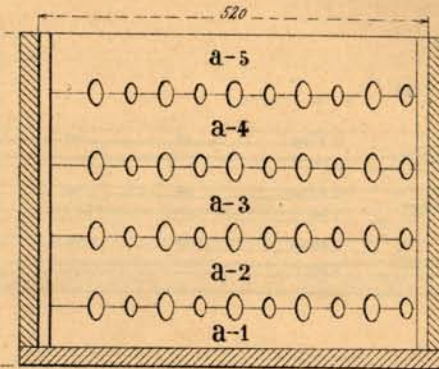


Echelle ($\frac{1}{10}$).

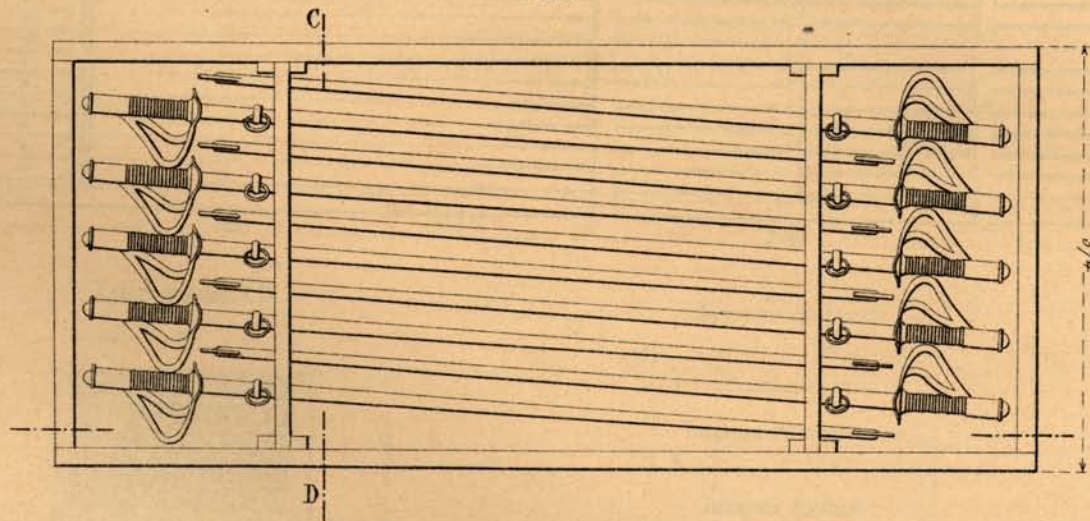
Coupe montrant la disposition des armes.



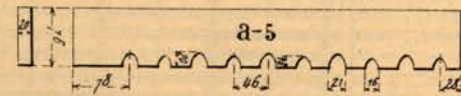
Coupe suivant CD.



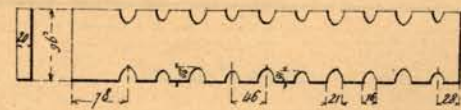
Plan



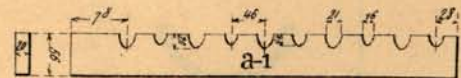
Tasseau de dessus.



Tasseau intermédiaire.



Tasseau de fond.

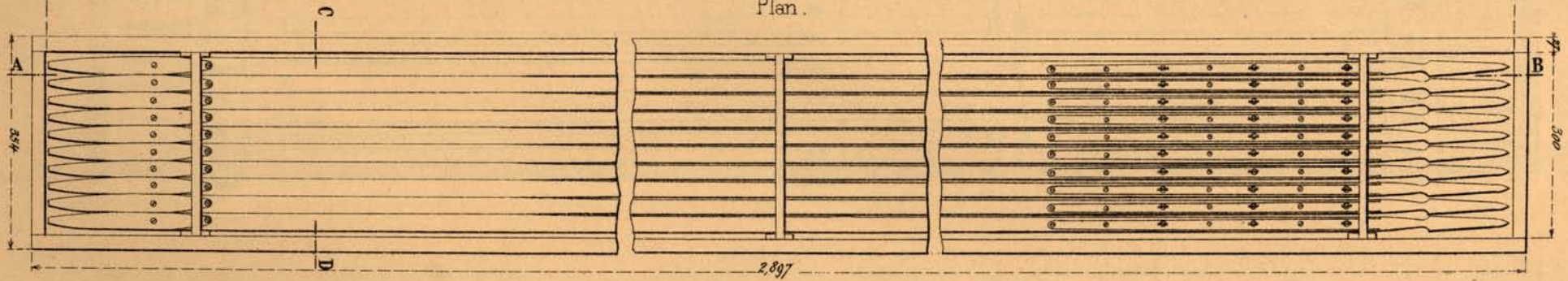


Echelle. ($\frac{1}{10}$).

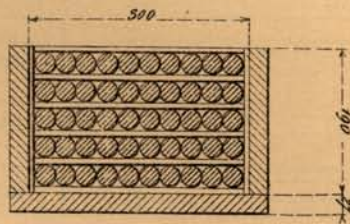
Coupe suivant AB.



Plan.



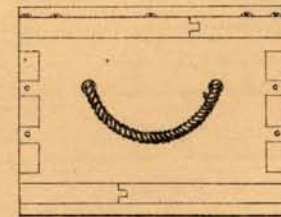
Coupe suivant CD.



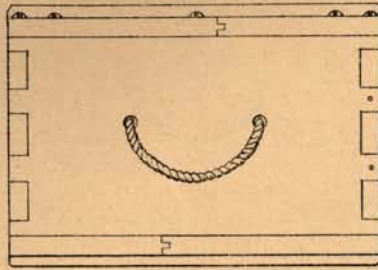
Tasseau de dessus.



Bout de la caisse.

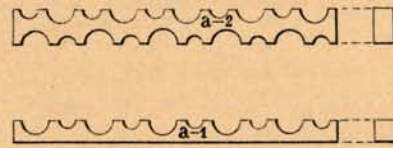


Bout de la caisse.

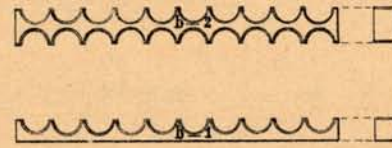


Echelle 1/5.

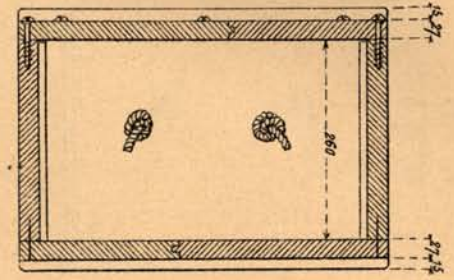
Tasseaux des extrémités.



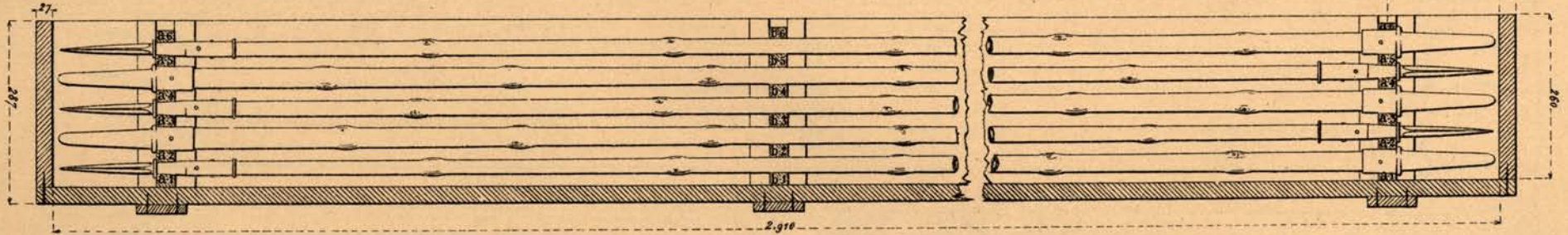
Tasseaux du milieu.



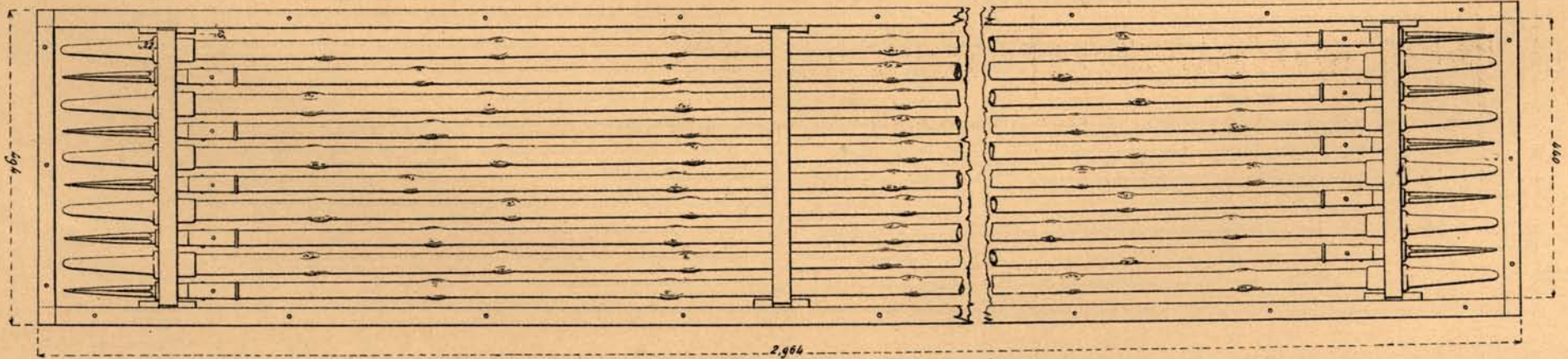
Coupe transversale.



Coupe longitudinale.



Plan.

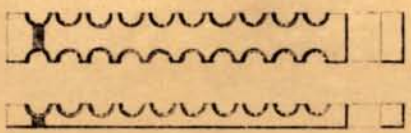


Echelle 1/6

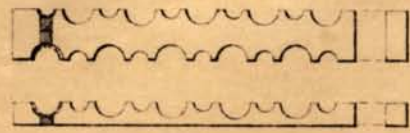
Bout de la caisse



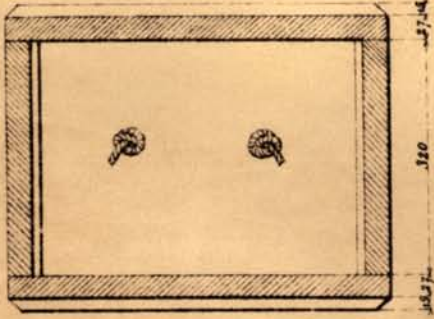
Tasseaux du milieu



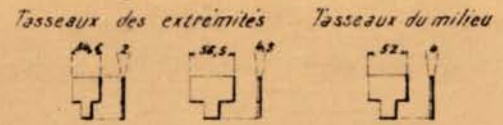
Tasseaux des extrémités



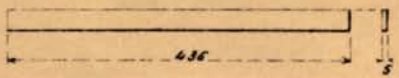
Coupe transversale



Cours pour tasseaux de caisse M^{le} 1913.



Planchette de calage pour lance M^{le} 1913

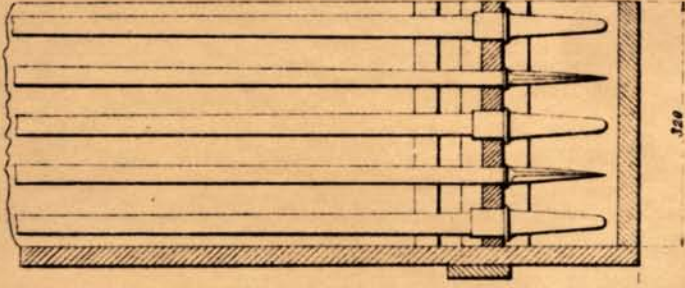


Chargement en lances M^{le} 1890.

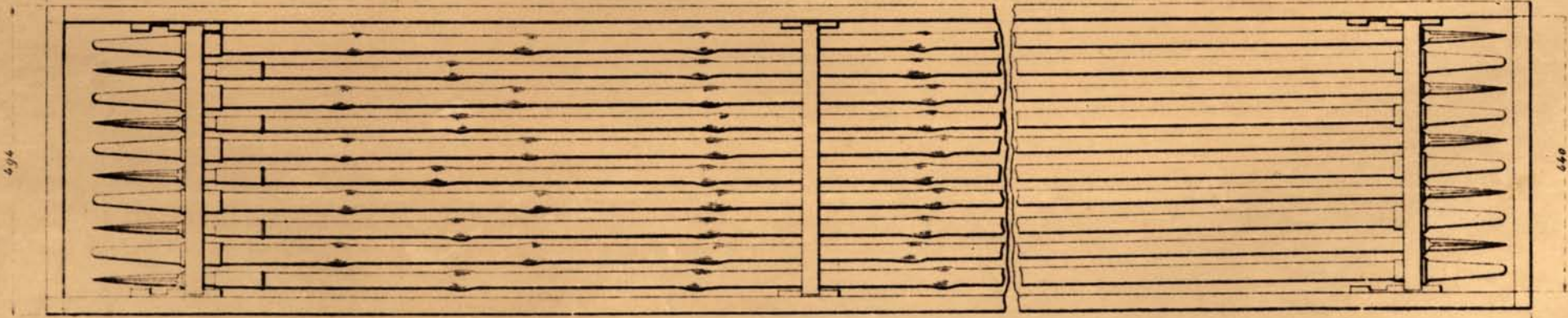


Coupe longitudinale.

Chargement en lances M^{le} 1913.



Plan



3,040

Echelle 4

Fig 1 Verrou de barillet.

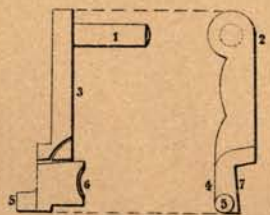


Fig 2 Porte.

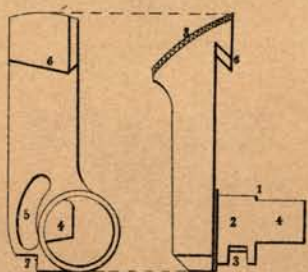


Fig 3 Ressort de porte.

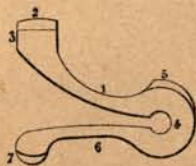


Fig 4 Chien

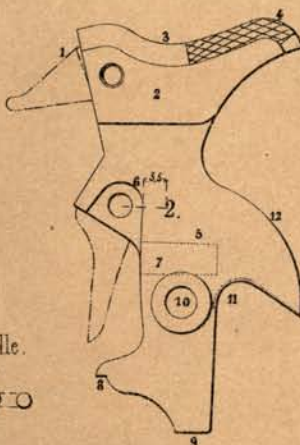


Fig 5 Percuteur oscillant.



Fig 6 Goupille de percuteur.



Fig 8 Vis de mentonnet



Fig 7 Mentonnet

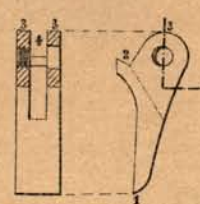


Fig 9 Ressort de mentonnet

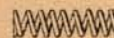


Fig 10 Détente

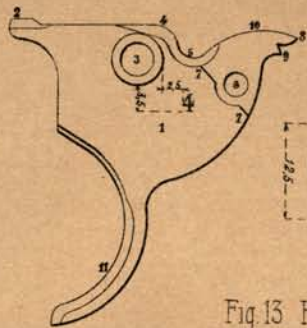


Fig 11 Barette

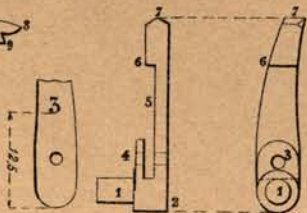


Fig 12 Galet de barette — Goupille.



Fig 14 Anneau de calotte et son pivot

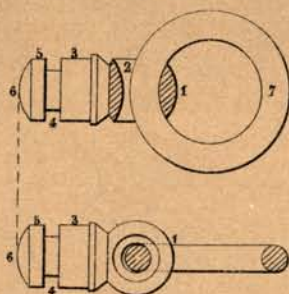


Fig 15 Verrou d'anneau de calotte

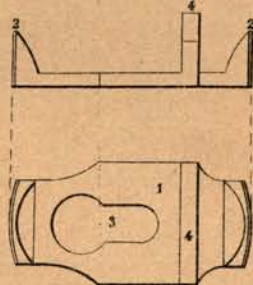


Fig 16 Plaquette droite (1/2)

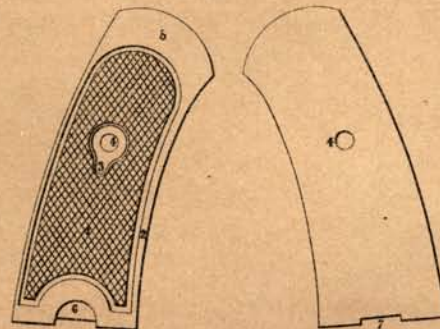
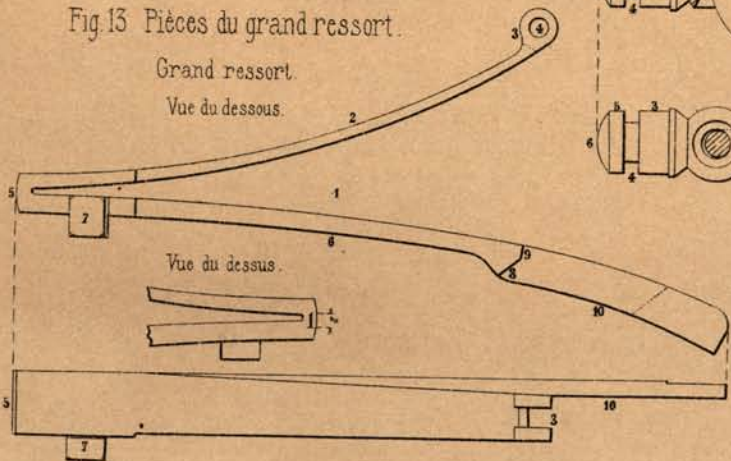


Fig 13 Pièces du grand ressort.

Grand ressort.
Vue du dessous.



Galet



Goupille de galet



Fig 18 Vis de montage



Fig 19 Rosette de montage

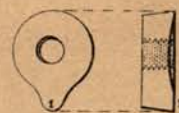
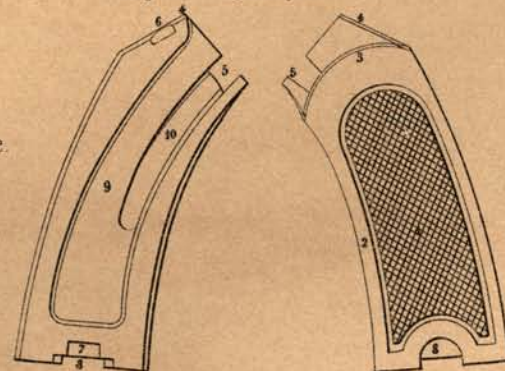


Fig 17 Plaquette gauche (1/2)



Sabres de cavalerie M^{le}1854 transformés. (†)

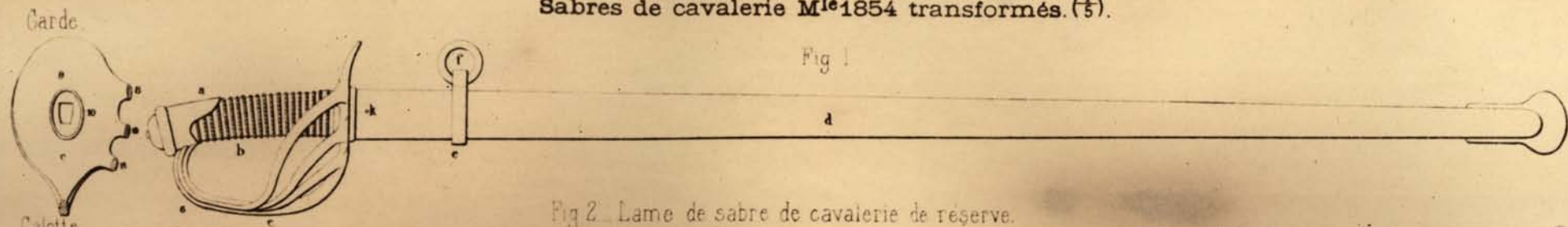


Fig 2. Lame de sabre de cavalerie de réserve.

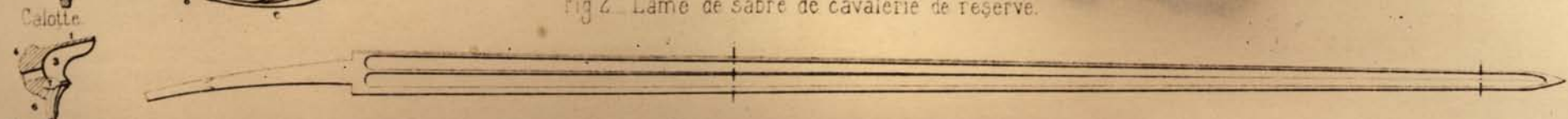
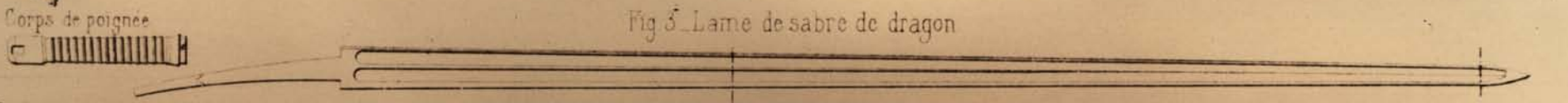


Fig 3. Lame de sabre de dragon



Coupes
↓ ↓

Sabres de cavalerie M^{le}1882.

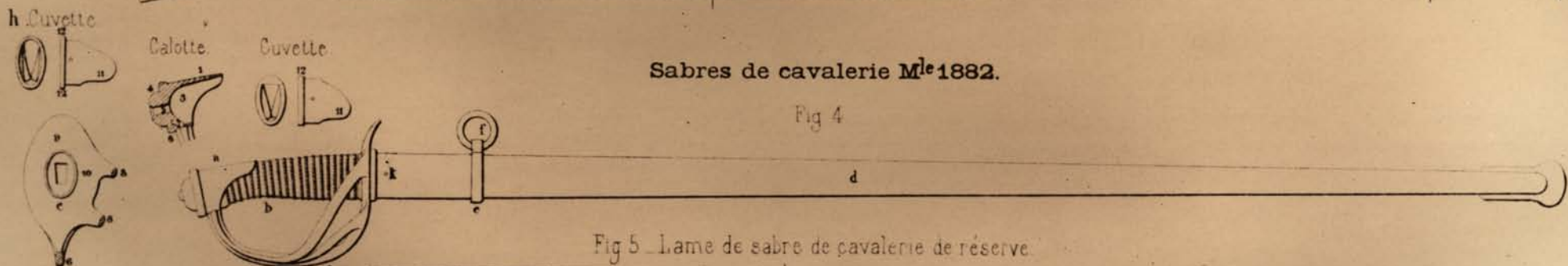


Fig 5. Lame de sabre de cavalerie de réserve.

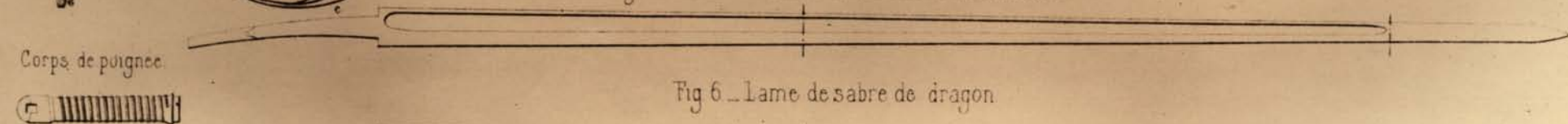


Fig 6. Lame de sabre de dragon

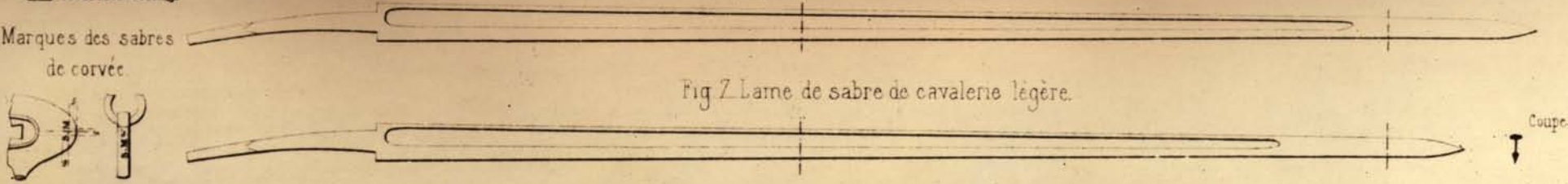


Fig 7. Lame de sabre de cavalerie légère.

Coupes
↓ ↓

Sabres de cavalerie M^lo 1896.

Fig.1 Ensemble. ($\frac{1}{5}$)

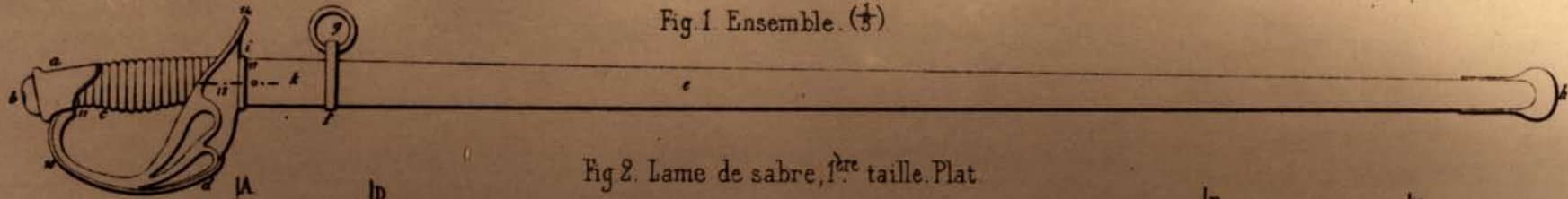


Fig 2. Lame de sabre, 1^{re} taille. Plat.

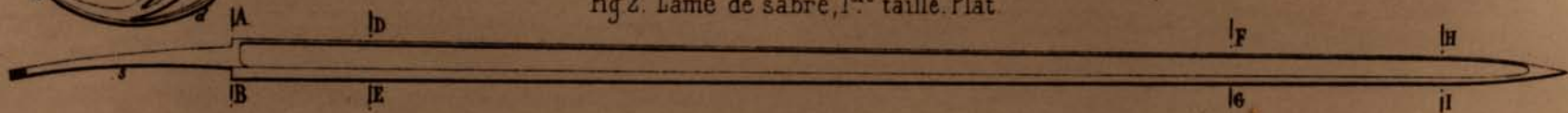


Fig 3. Dos de la lame.

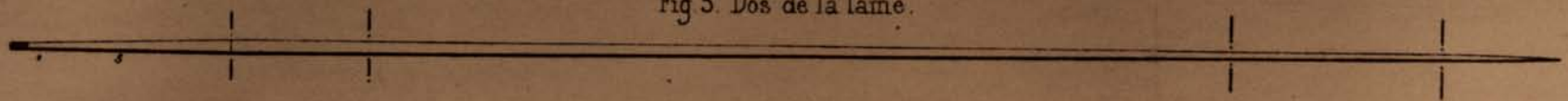


Fig 4. Lame de sabre 2^e taille. Plat.

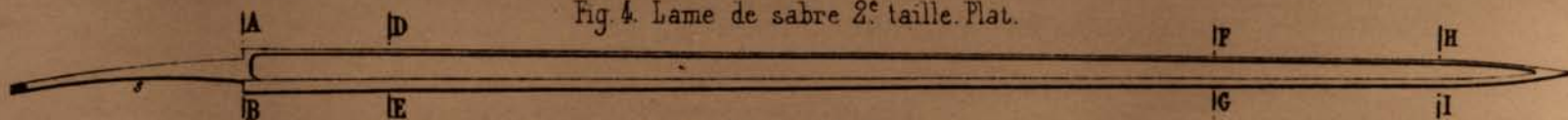


Fig.5. Dos de la lame.

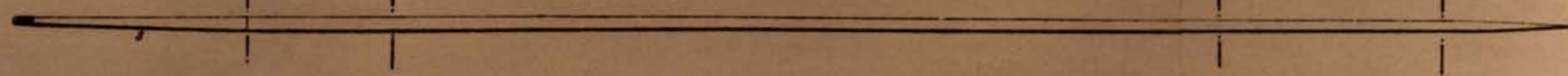


Fig 10 Coupes

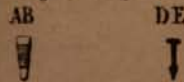


Fig 10. Coupes

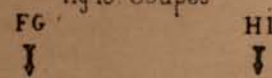
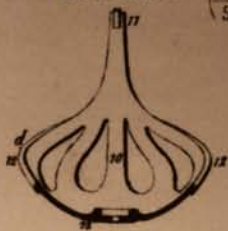


Fig.6. Garde.

Elevation ($\frac{1}{5}$)



Plan.



Fig 7 Calotte.

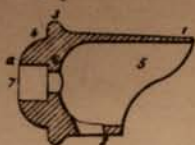


Fig 8 Ecrrou de monture.



Fig 9 Corps de poignée



Fig 11 Cuvette.



Fig 12. Bracelet.

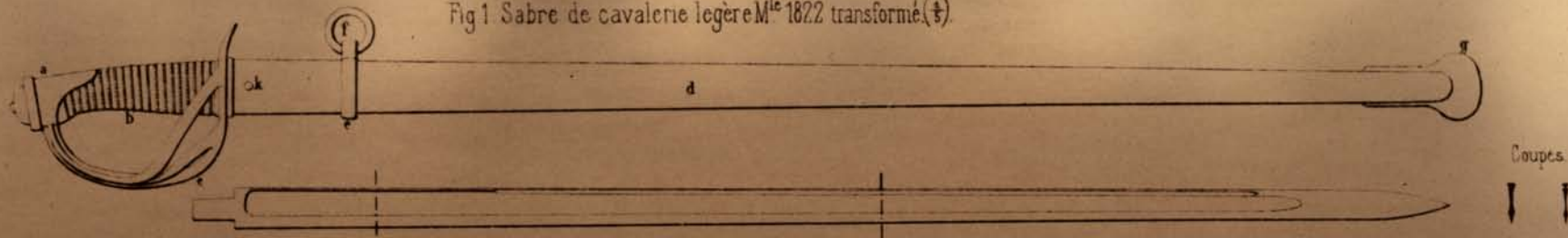


Détails communs ($\frac{1}{5}$)

c Garde



Fig 1 Sabre de cavalerie legere M^{le} 1822 transformé (1/3)



h Cuvette



Fig 2 Sabre de cavalerie legere M^{le} 1822 (1/3)

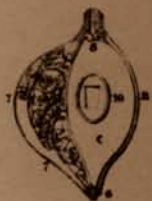
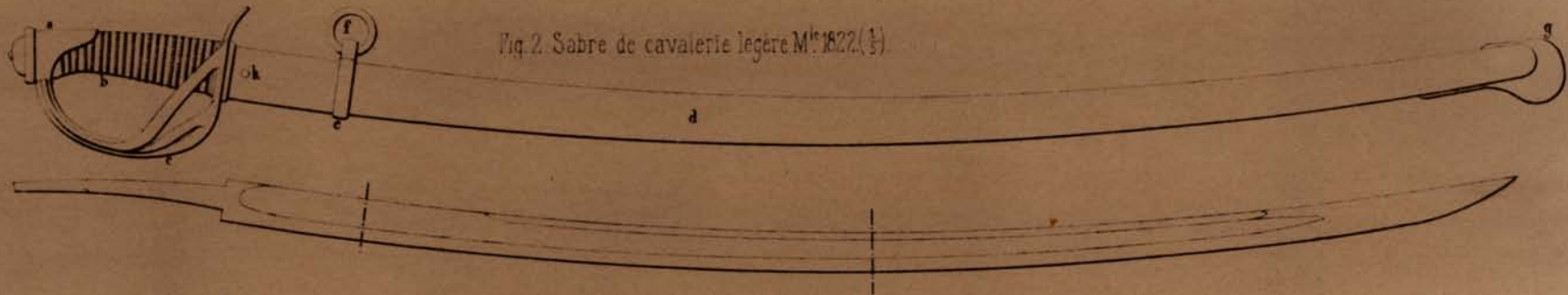
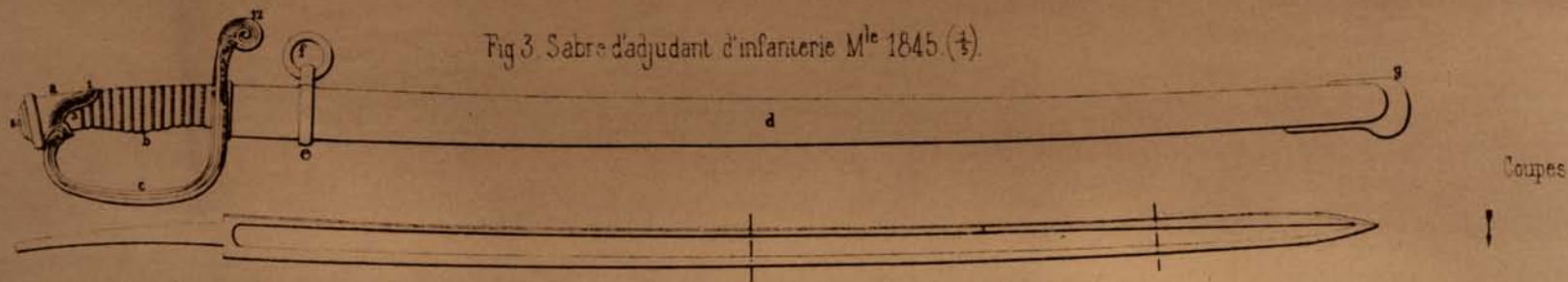


Fig 3 Sabre d'adjudant d'infanterie M^{le} 1845 (1/3)



d Croisiere

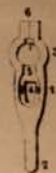
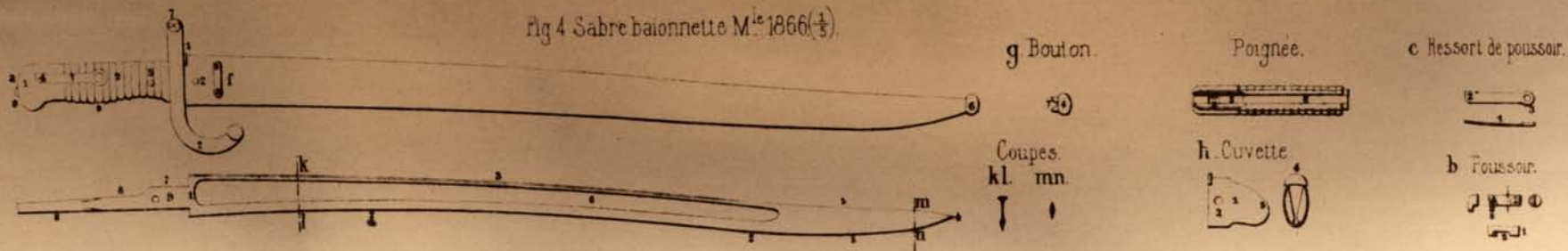


Fig 4 Sabre baionnette M^{le} 1866 (1/3)



e Vis de croisiere



g Bouton

Poignee.

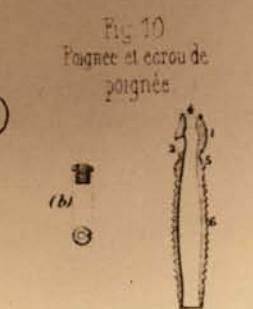
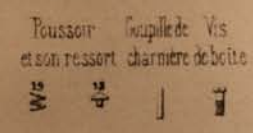
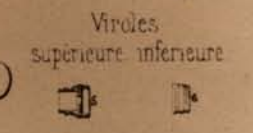
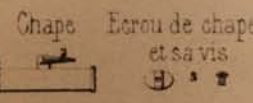
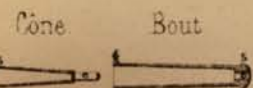
e ressort de poussoir.

Coupes.
kl. mn.

h Cuvette

b Foussoir.

Fig 1. Epée de sous-officier et de brigadier de gendarmerie.
M^{le} 1853.



Section en a.
fourreau en cuir.
O^d

Section en b.
du fourreau métallique
O

Section en C et d.

Section en e.
du fourreau métallique.
O

Section en f.

Fig 2



Fig 4

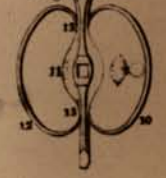


Fig 6. Garde

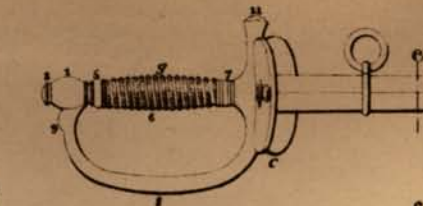
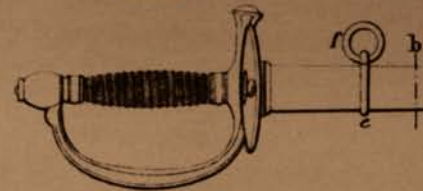
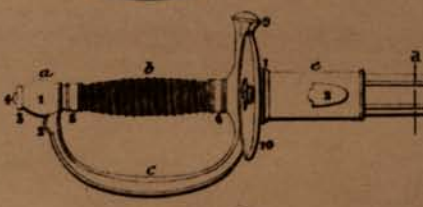
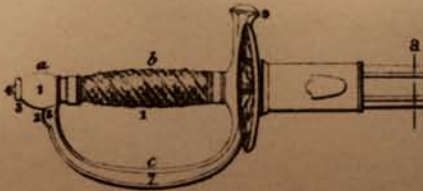
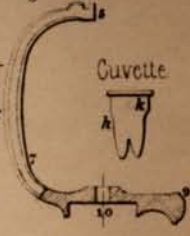


Fig 3 Epée de sous-officier
M^{le} 1857.

Fig Epée de sous-officier
M^{le} 1884.

Fig 7. Lame commune aux 3 épées.

Fig 8. Epée de sous-officier.
M^{le} 1887.

Lame

Fig 1 Lance M^{le} 1913 ($\frac{1}{12}$).

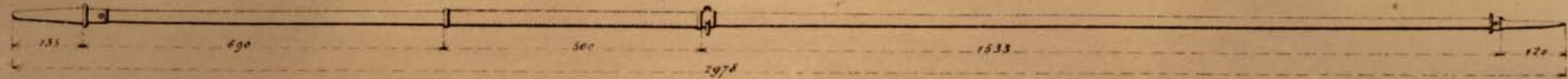


Fig 1^{bis} Hampe ($\frac{1}{12}$).

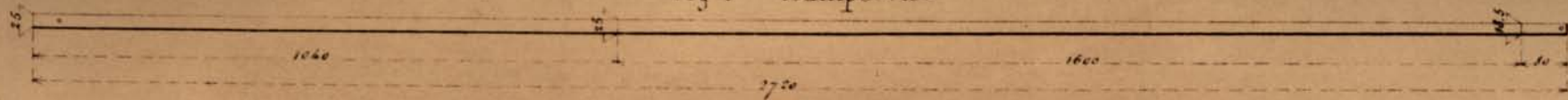


Fig 2 Monture de la partie postérieure de la lance ($\frac{1}{4}$).



Fig 2^{bis} Bracelet ($\frac{1}{4}$).

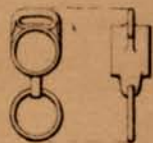


Fig 2^{ter} Monture de la partie antérieure de la lance ($\frac{1}{4}$).

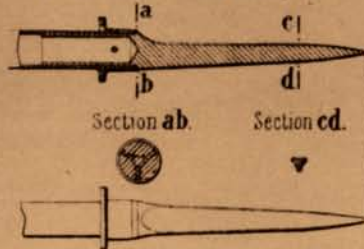


Fig 3. Garde-main ($\frac{1}{4}$).

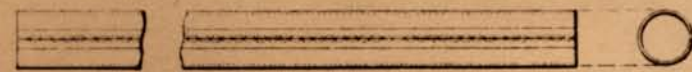


Fig 3^{bis} Viroles postérieure ($\frac{1}{4}$) antérieure.

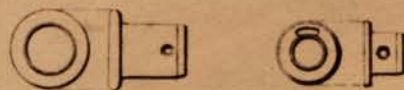


Fig 3^{ter} Bagues d'assemblage du garde-main antérieure ($\frac{1}{4}$) postérieure.



Fig 4 Lance. M^{le} 1890 ($\frac{1}{12}$).

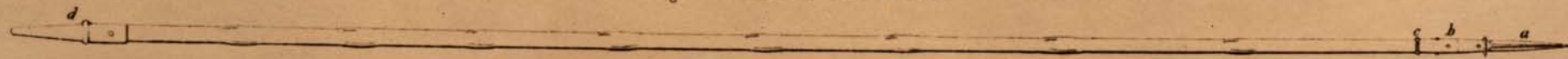


Fig 5 Sabot ($\frac{1}{4}$).

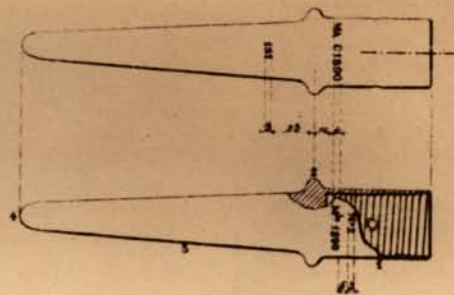


Fig 6 Douille ($\frac{1}{4}$) Coupe longitudinale.

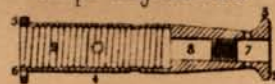
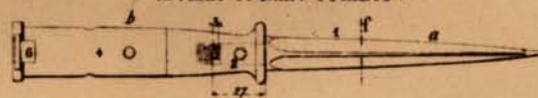


Fig 7 Fer de lance ($\frac{1}{4}$). (Douille et lame réunies)



Section en f



Fig 8 Parties emmanchées de la lance.

Extrémité et tampon postérieur



Extrémité et tampon antérieur



Fig 9 Bracelet pontet ($\frac{1}{4}$).



Fig 1. Lance M^{le} 1823. ($\frac{1}{2}$).



Fig 2. Fer de lance ($\frac{1}{4}$).

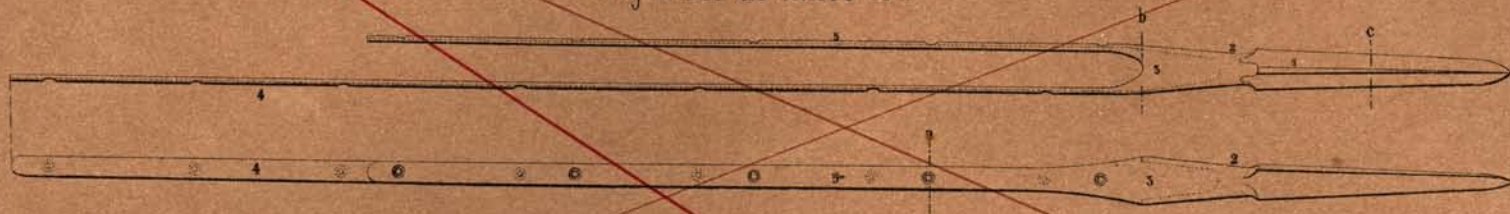


Fig 3. Sabot. ($\frac{1}{4}$).

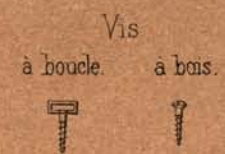
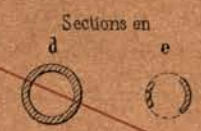
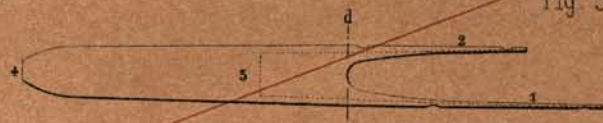


Fig 4 Lance M^{le} 1890. ($\frac{1}{2}$).



Fig 5 Sabot ($\frac{1}{4}$).

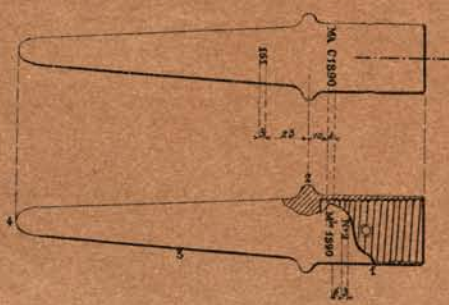


Fig 6 Douille ($\frac{1}{4}$)
Coupe longitudinale.

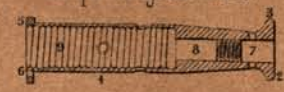


Fig 7. Fer de lance ($\frac{1}{4}$)
(Douille et lame réunies)

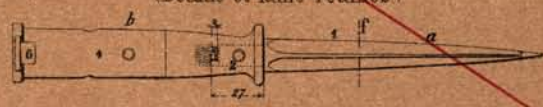


Fig 8 Parties emmanchées de la lance

Extrémité et tampon postérieur.



Extrémité et tampon antérieur.



Fig 9. Bracelet-pontet. ($\frac{1}{4}$)



PL. XXII.

Sabres d'officiers. 5)

Fig 1 Sabre d'officiers généraux.

Poignée ornée des étoiles du grade {
 5 pour les Généraux de Division.
 2 pour les Généraux de Brigade.
 7 pour les Maréchaux de France.

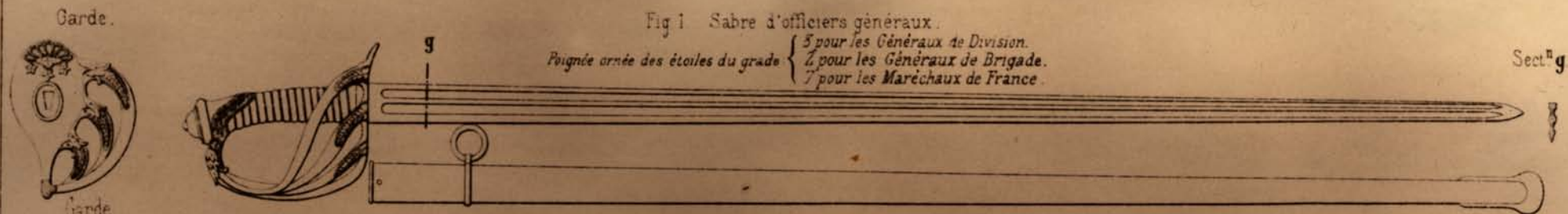


Fig 2 Sabre d'officier de cavalerie M^{le} 1896

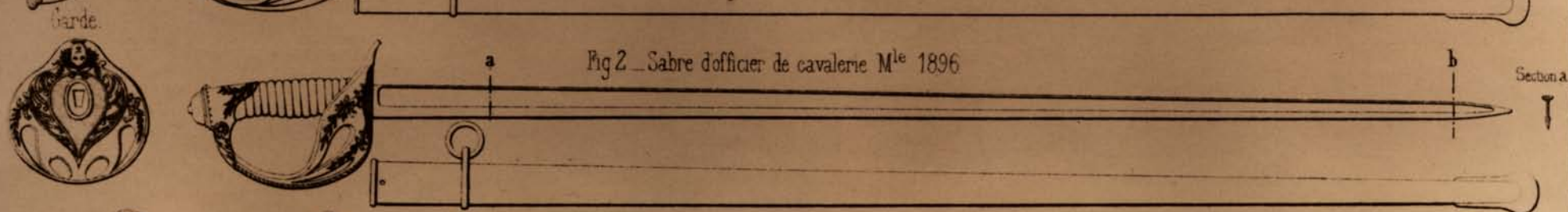


Fig 3 Sabre d'officier de cavalerie M^{le} 1896. (Poignée ornée des étoiles du grade pour général de division)

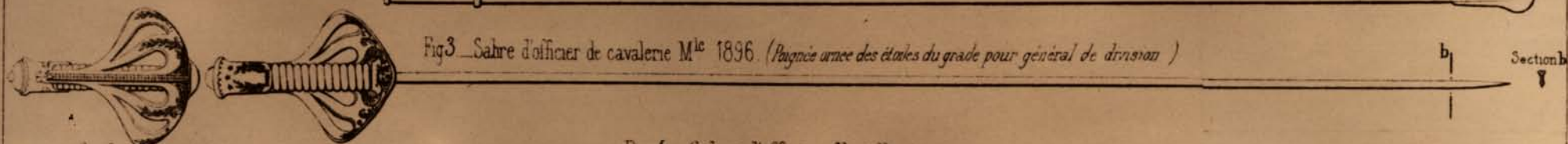


Fig 4 Sabre d'officier d'artillerie
 M^{le} 1822-99.

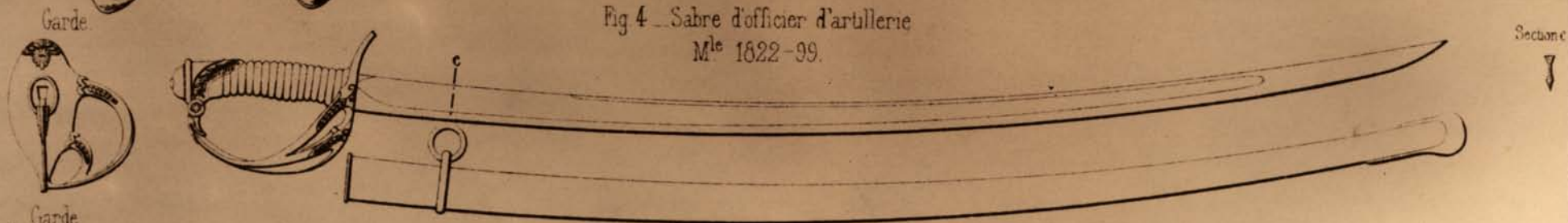
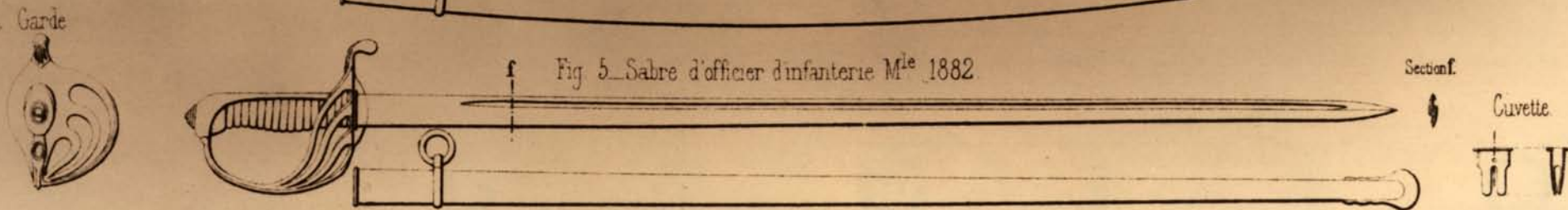


Fig 5 Sabre d'officier d'infanterie M^{le} 1882.



PL. XXIII.

Epées d'officiers. (1/5).

Fig. 1. Epées à ciselures.

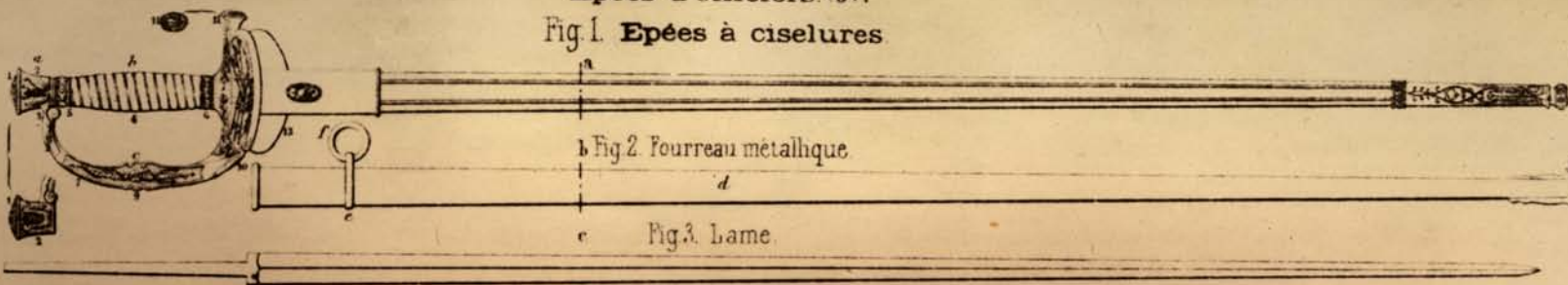


Fig. 2. Fourreau métallique.

Fig. 3. Lame.

Fig. 4. Lame (Officier sup^r de Gendarmerie).

Fig. 5. Epées sans ciselures.

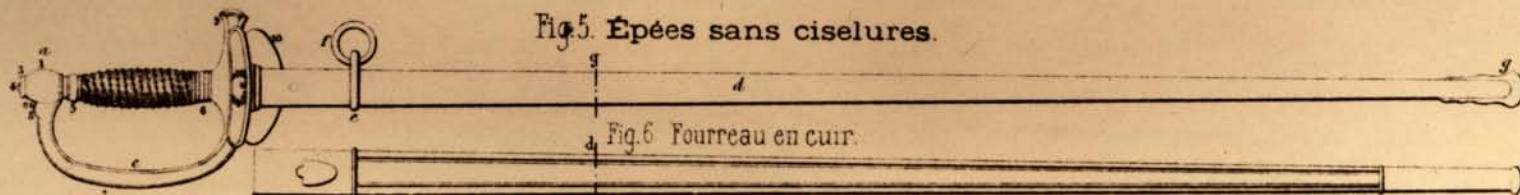
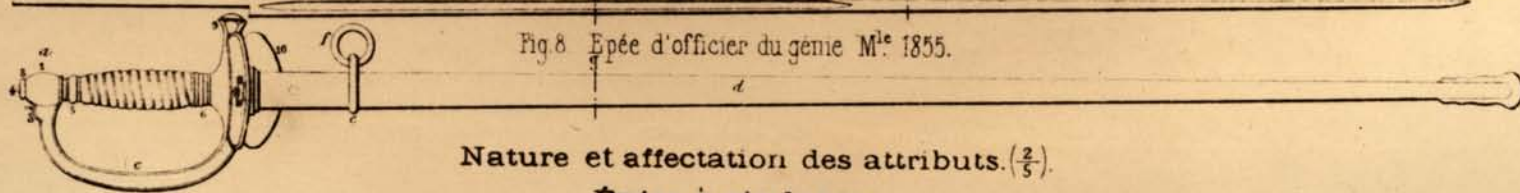


Fig. 6. Fourreau en cuir.

Fig. 7. Lame.

Fig. 8. Epée d'officier du génie M^{le} 1855.



Section en a.
Fourreau en cuir.

Section en b.

Section en c.

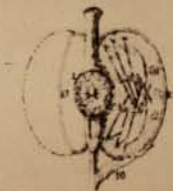
Sections en e en f.

Cuvette.

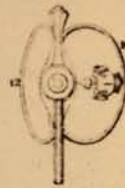
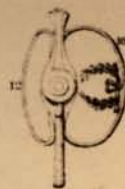
Section en d.
Fourreau en cuir.

Sections en e en f.

Section en g.
Fourreau métallique.



Coupe de la chape.
Fourreau en cuir.



Nature et affectation des attributs. (2/5).

Epées à ciselures.

Fig. 9. Officiers généraux et assimilés.

Fig. 10. Artillerie. Officiers d'admⁿ principaux. Officiers d'admⁿ contrôleurs d'armes princ^{es}.

Fig. 11. Génie. Officiers sup^r (4 drapeaux). Officiers d'admⁿ princ^{es} (6 drapeaux).

Fig. 12. Officiers d'admⁿ principaux du service état-major.

Fig. 13. Service de santé.

Fig. 14. Justice militaire.

Fig. 15. Interprètes militaires.

Fig. 16. Attribut général.



Fig. 17. Corps du contrôle.

Fig. 18. Artillerie.

Fig. 19. Génie.

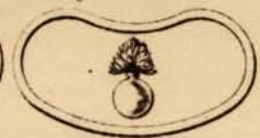
Fig. 20. Etat-major.

Fig. 21. Service de santé.

Fig. 22. Justice militaire.

Fig. 23. Officiers des établissements pénitentiaires.

Fig. 24. Attribut général.



Cuirasse de cuirassier M^{le} 1855.

Fig. 1. Cuirasse garnie (1/8)

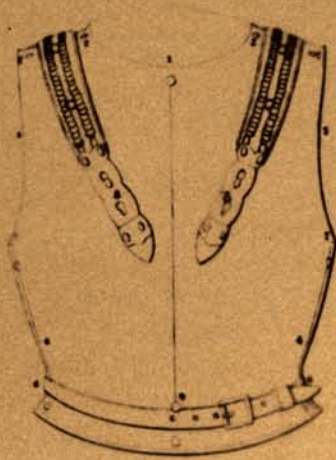


Fig. 2. Vue intérieure du dos Marques (1/8)

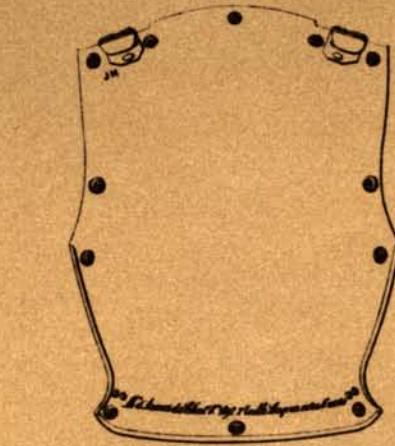
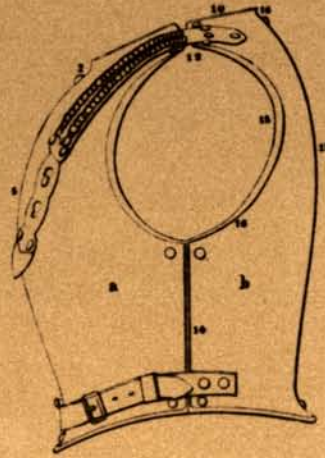


Fig. 3. Grande courroie de ceinture (1/4)

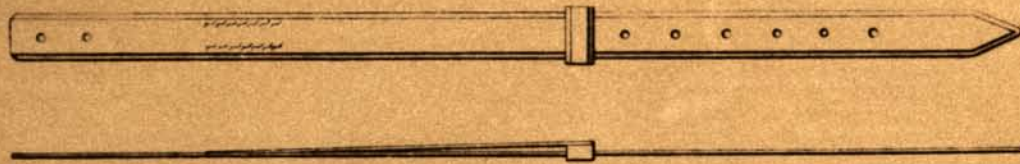


Fig. 4. Petite courroie de ceinture (1/4)

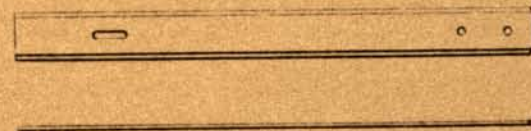


Fig. 5. Bretelle (1/4)



Fig. 8. Bouton de bretelle (1/4)



(1/4)

Fig. 9. Bouton de ceinture

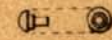


Fig. 6. Boucle (1/4)

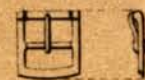


Fig. 7. Support de plastron (1/4)

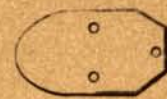


Fig. 10. Clou rive



Fig. 11. Rosette



Cartouches pour fusils, carabines et mousqueton. (†)

Fig.1. Cartouche M^{le} 1886 M.

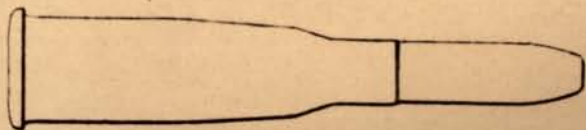


Fig. 2. Cartouche à blanc M^{le} 1897.

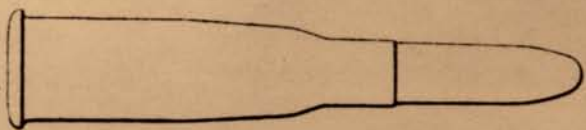


Fig. 3. Fausse cartouche M^{le} 1886.



Fig. 4. Fausse cartouche M^{le} 1892.

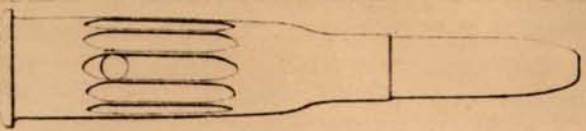


Fig. 5. Cartouche de tir réduit M^{le} 1895.

Balle à enveloppe en cuivre.

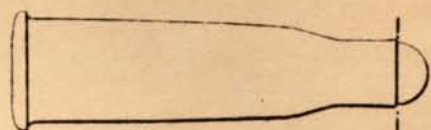


Fig. 15. Coupe de la balle.



Fig. 7. Coupe de la Cartouche M^{le} 1886 M.

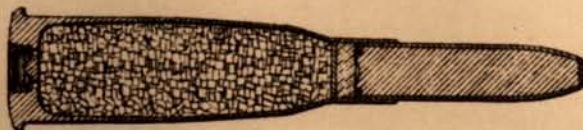


Fig. 11. Coupe de la cartouche à blanc. Etui M^{le} 1886 M.

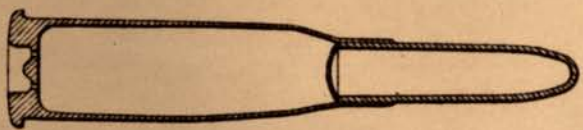
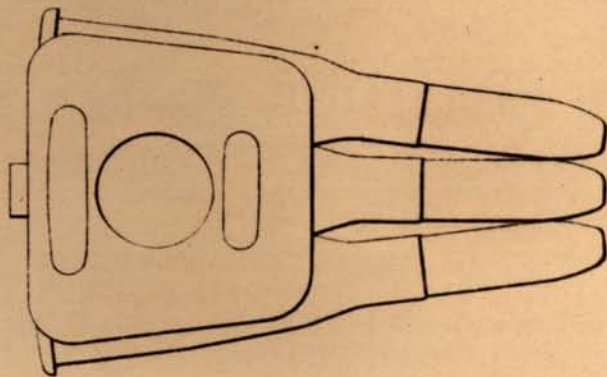


Fig. 16. Chargeur M^{le} 1890.



Fond. Vue postérieure. Vue antérieure.

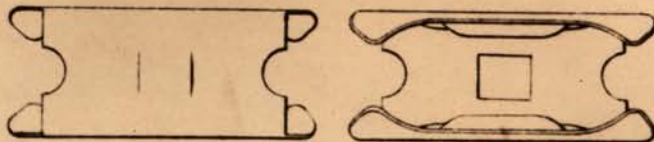


Fig. 7^{bis}. Coupe de la cartouche M^{le} 1886 D.



Fig. 7^{ter}. Balle M^{le} 1898.

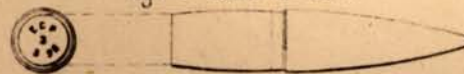
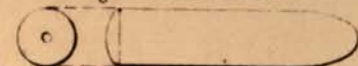


Fig. 8. Balle M^{le} 1866.



Fig. 12. Fausse balle.



Amorçage des cartouches.

Fig. 9. M^{le} 1886.

Fig. 6. M^{le} 1890.

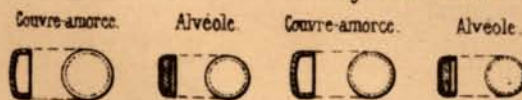


Fig. 10. Bourre des Cartouches M^{le} 1886 et M^{le} 1886 M.

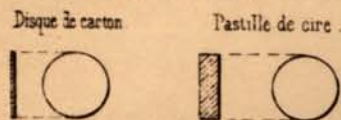
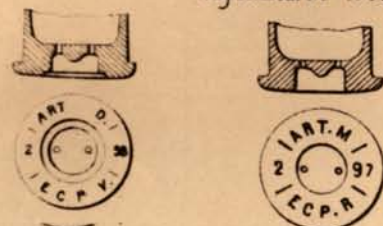


Fig. 13. Etui M^{le} 1886 D.

Fig. 14. Etui M^{le} 1886 M.



Cartouches pour fusils, carabines et mousqueton. (†)

Fig.1. Cartouche M^{le} 1886 M.



Fig.7. Coupe de la. Cartouche M^{le} 1886M.

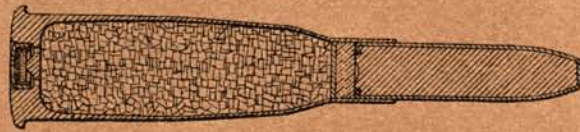


Fig.8. Balle M^{le} 1886.



Fig.2. Cartouche à blanc M^{le} 1897.



Fig.11. Coupe de la cartouche à blanc. Etui M^{le} 1886. M.

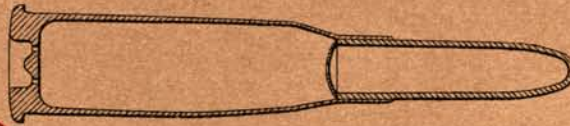


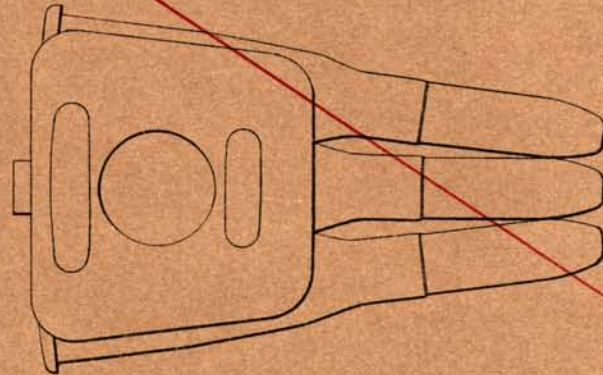
Fig.12. Fausse balle.



Fig.3 Fausse cartouche M^{le} 1886.



Fig.16 Chargeur M^{le} 1890.



Amorçage des cartouches.

Fig.9. M^{le} 1886.

Fig.6. M^{le} 1890.

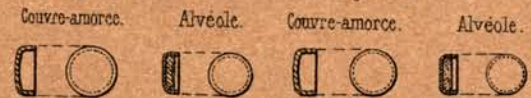


Fig.4 Fausse cartouche M^{le} 1892.

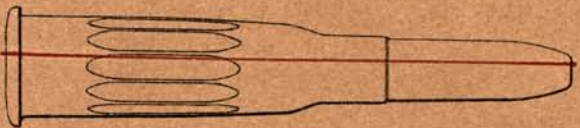


Fig.10. Bourre des Cartouches M^{le} 1886. et M^{le} 1886. M

Disque de carton.

Pastille de cire.



Fig.5 Cartouche de tir réduit M^{le} 1895.

Balle à enveloppe en cuivre.



Fig.15 Coupe de la balle.



Vue postérieure.

Fond.

Vue antérieure.

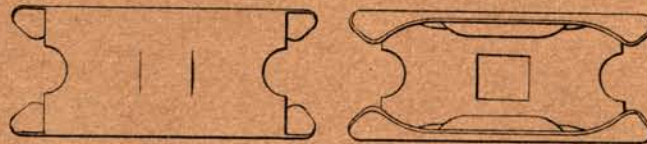
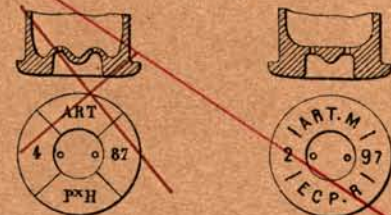


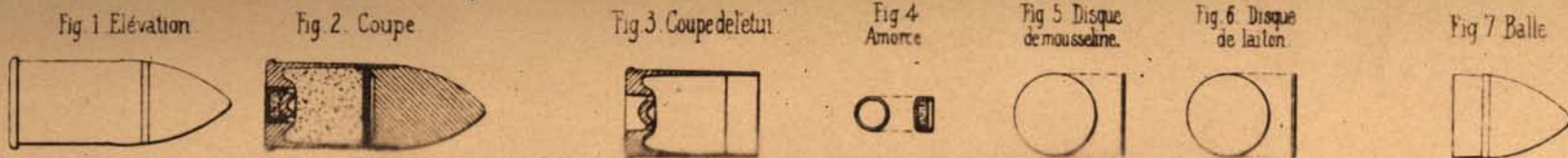
Fig.13. Etui M^{le} 1886.

Fig.14. Etui M^{le} 1886 M.

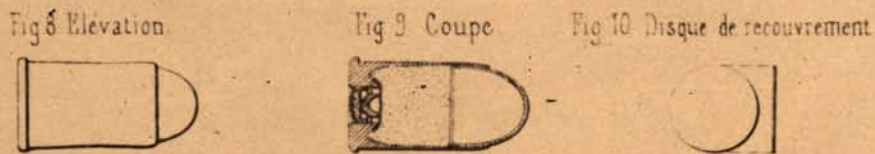


Cartouches pour revolver M^{le} 1873 et M^{le} 1874. (1/2).

Cartouche M^{le} 1873 - 90

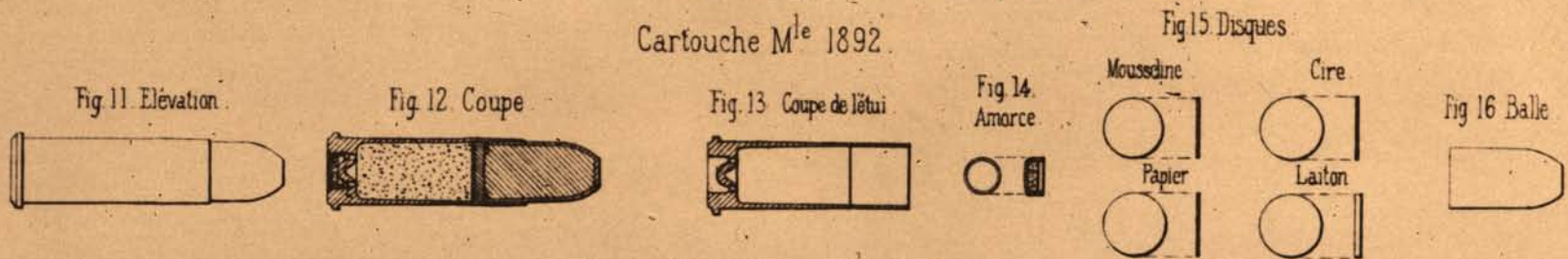


Cartouche a blanc M^{le} 1890-1900



Cartouches pour revolver M^{le} 1892. (1/2).

Cartouche M^{le} 1892.



Cartouche à blanc M^{le} 1892.



PL XLIX

Cartouches pour revolver M^{le} 1873 et M^{le} 1874. (1/1)

Cartouche M^{le} 1873 - 90

Fig. 1. Elévation.

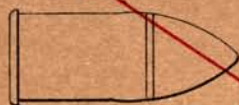


Fig. 2. Coupe.

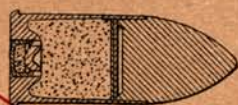


Fig. 3. Coupe de létui.

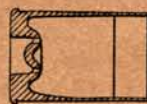


Fig. 4. Amorce.



Fig. 5. Disque de mousseline.



Fig. 6. Disque de laiton.



Fig. 7. Balle.

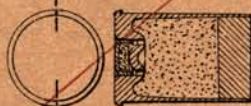


~~Cartouche sans balle M^{le} 1873.~~

~~Fig. 8. Elévation.~~



~~Fig. 9. Coupe.~~



~~Fig. 10. Bourre.~~



Cartouches pour revolver M^{le} 1892. (1/1)

Cartouche M^{le} 1892.

Fig. 11. Elévation.



Fig. 12. Coupe.



Fig. 13. Coupe de létui.



Fig. 14. Amorce.



Fig. 15. Disques.

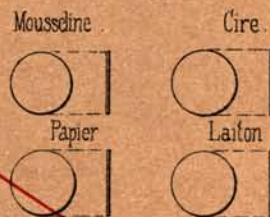


Fig. 16. Balle.



Cartouche à blanc M^{le} 1892.

Fig. 17. Elévation.

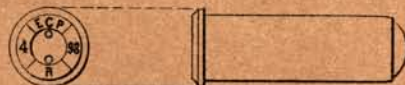


Fig. 18. Coupe.

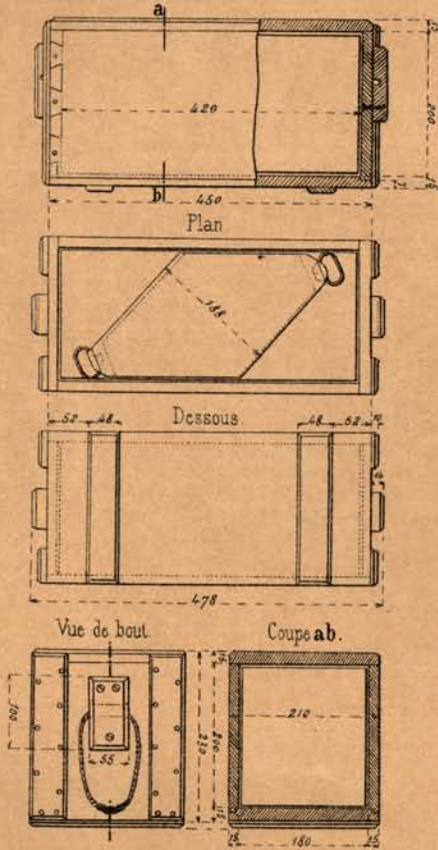


Fig. 19. Balle.



PL. XLIX.

Fig. 5. Caisse blanche M¹e T
avec caisse intérieure en zinc.
Elevation et coupe longitudinale.



Planchette de la caisse M¹e T.

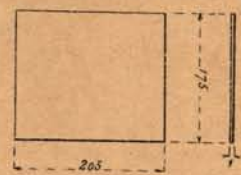


Fig. 6. Caisse C.1
avec caisse intérieure en zinc.
Elevation et coupe longitudinale. Vue de bout.

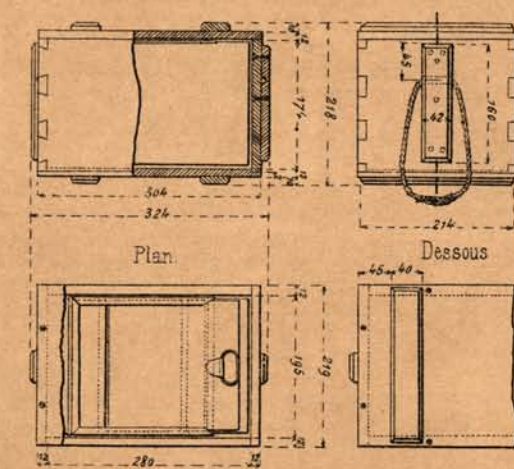


Fig. 7. Caisse C.1^{bis}
avec caisse intérieure en zinc.
Elevation et coupe longitudinale. Vue de bout.

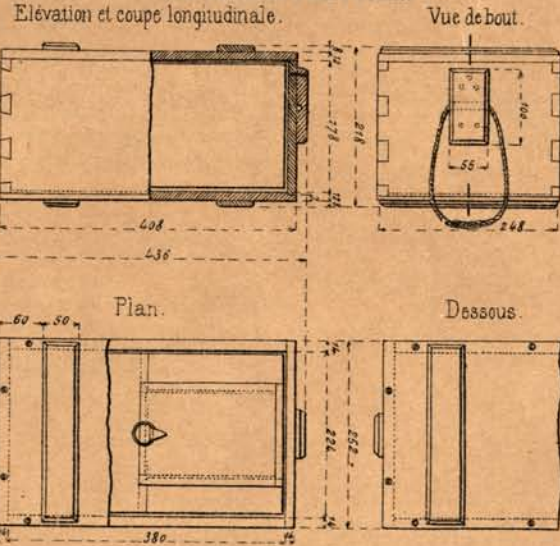


Fig. 8. Caisse C.2
avec caisse intérieure en zinc.
Elevation et coupe longitudinale. Vue de bout.

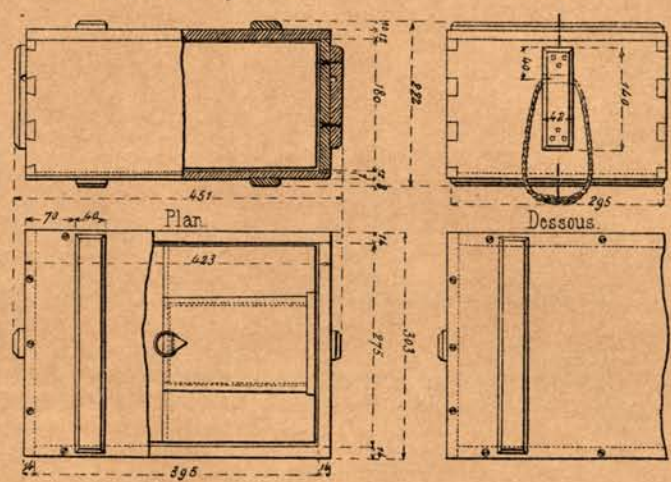


Fig. 9. Caisse C.2^{bis}
avec caisse intérieure en zinc.
Elevation et coupe longitudinale. Vue de bout.

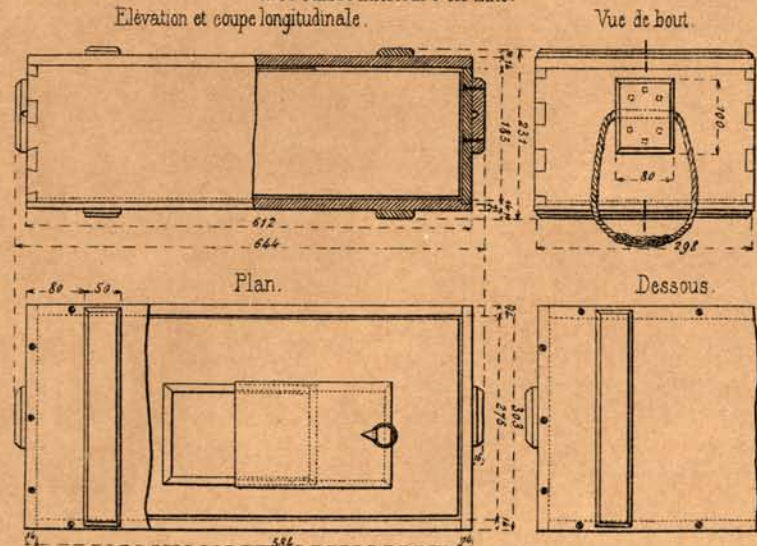


Fig.1. Coffre M^{le} 1858 non allongé.
Élévation et coupe longitudinale.

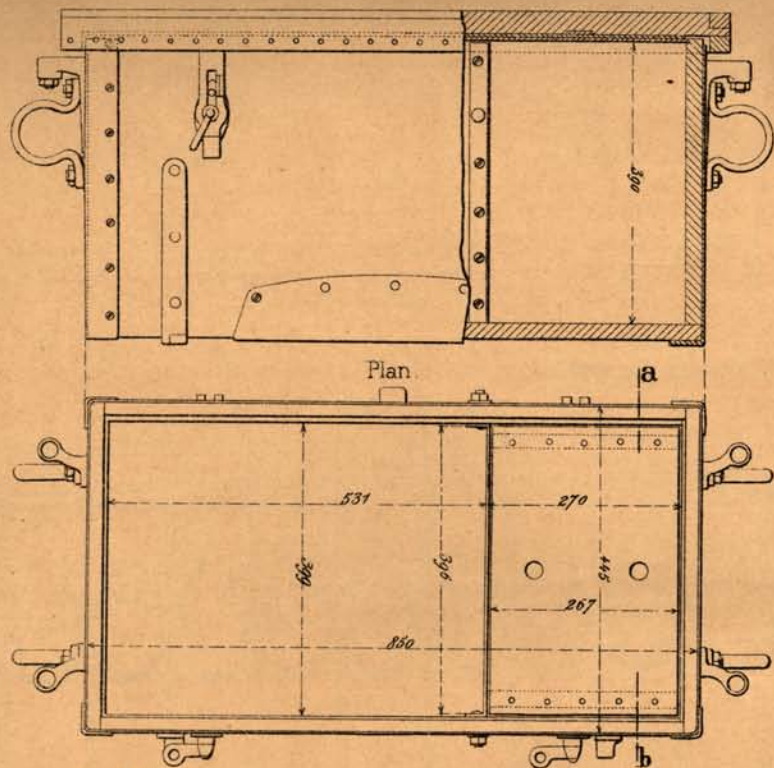


Fig. 2. Vue de bout.

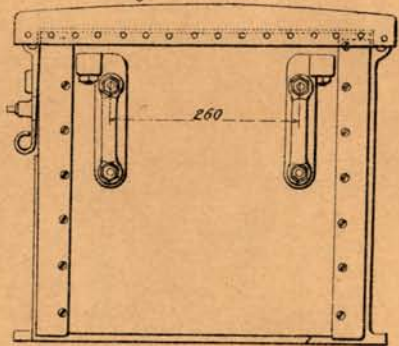


Fig. 3.
Planche de pression.

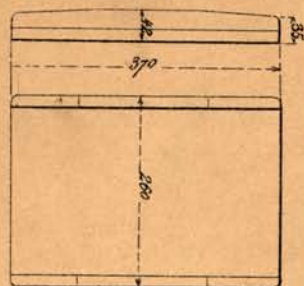


Fig.4. Coffre M^{le} 1858 allongé.
Élévation et coupe longitudinale.

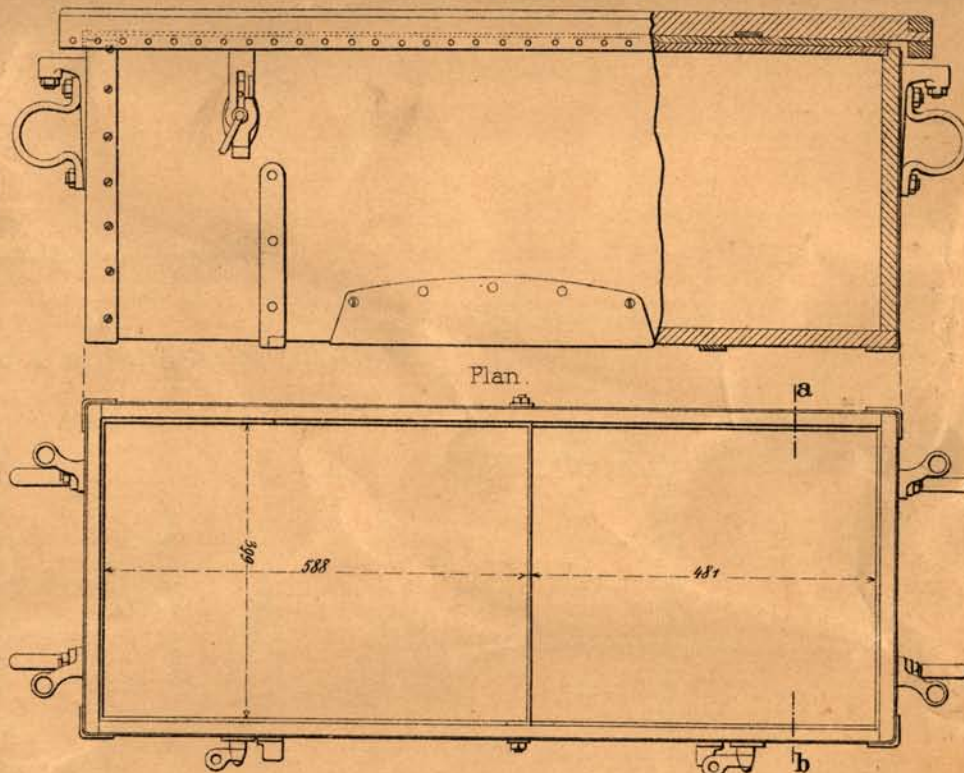


Fig. 6. Bissac déployé.
Plan.

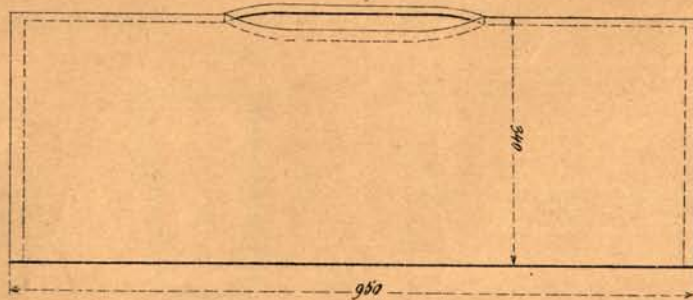
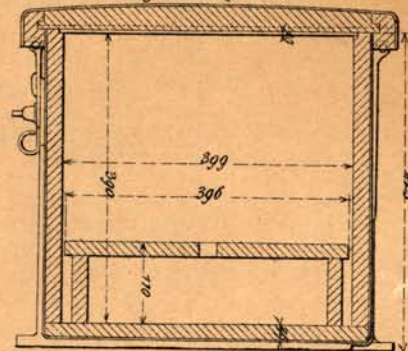


Fig. 5. Coupe ab



Coffre à munitions de voiture de compagnie M^{le} 1891.

Fig. 1. Elevation.

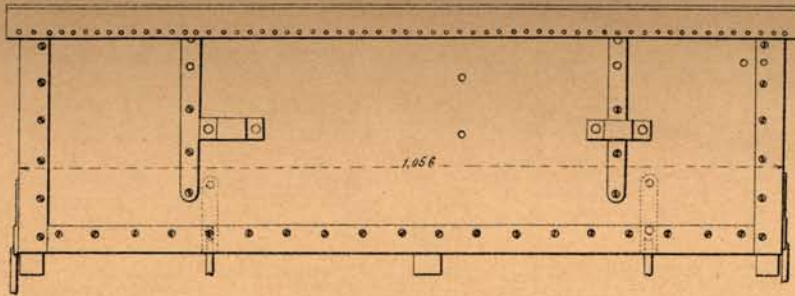


Fig. 2. Coupe ab.

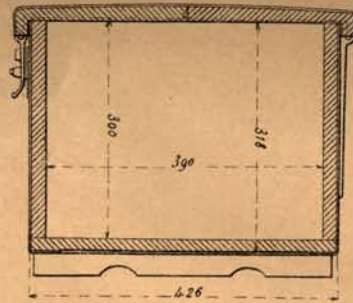
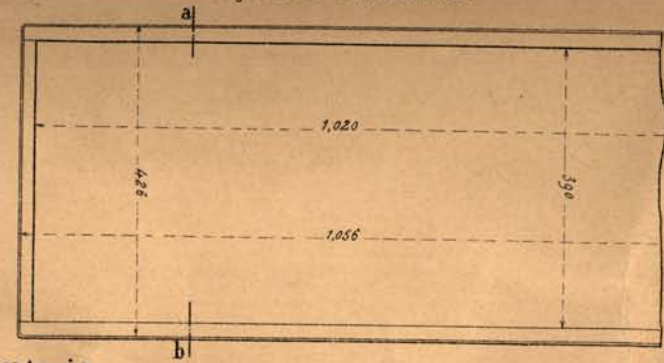


Fig. 3. Plan (sans couvercle).



Coffre de caisson léger à munitions d'infanterie.

Fig. 4. Elevation.

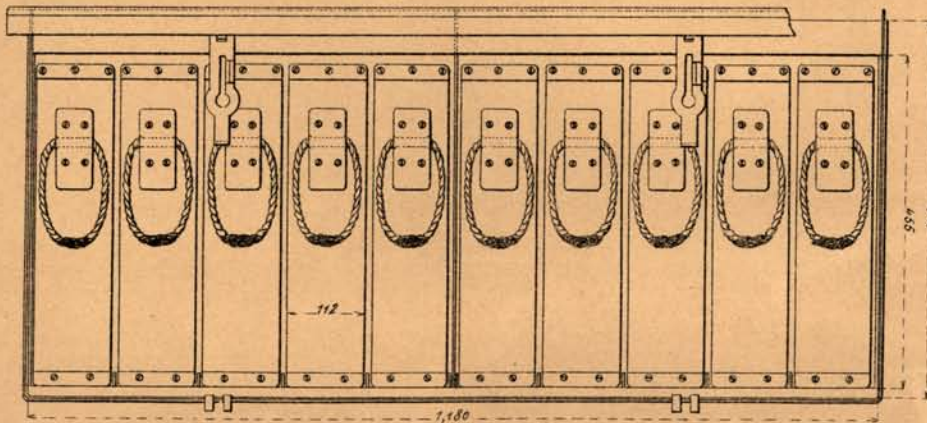


Fig. 6. Caisse à cartouches.

Coupe cd.



Elévation et coupe longitudinale.

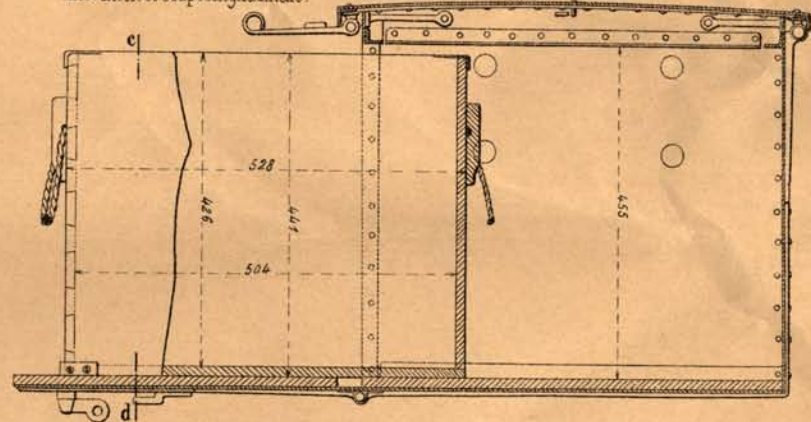


Fig. 5. Coupe.

Caisse à munitions de montagne M^{le} 1862.

Fig. 7. Elevation.

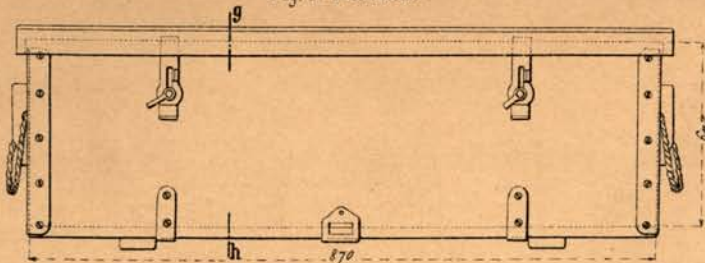
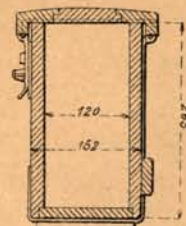
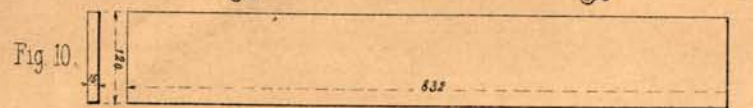
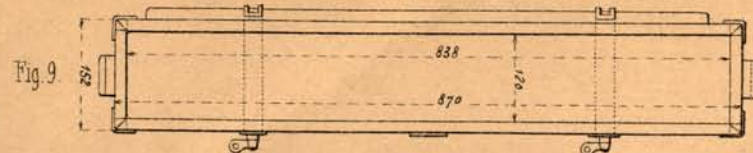


Fig. 8. Coupe gh.



Plan de la caisse et de la planchette de remplissage.



PL. LIII.